



VENTILATION PRODUCTS

A comprehensive range of stylish and functional ventilation solutions.

www.jpbrands.com.au

Supporting Retailers Since 1978

With over 40 years of experience in the home hardware retail industry, JPM International is a leading Australian owned importer and distributor operating from Bayswater, Victoria.

Our commitment is to provide you with the most effective ventilation solutions through high-quality products, unparalleled pricing and passionate customer service.





Rangehood Venting

Roof Venting Kits	5
Eave Venting Kits	6
Wall Venting Kits	7
Roof Universal Kits	8
Eave/Wall Universal Kits	9
Rangehood Adaptors	9
Rectangular Ducting	10-11

Dryer Venting

In-Laundry Venting (DVS System)	13-14
External Venting Kits (DVS System)	14-15
Components (DVS System)	16-17
Internal Venting Kits	17-18
External Venting Kits	18
Specific Dryer Kits	19

Air Transfer

Ceiling Exhaust Fan Kits	21-23
Heat Transfer Kits	24-25
Inline Fans	26
Diffusers	26-27
Flexible Ducting	27

Floor Vents

Polycarbonate Vents	29
ABS Plastic Vents	29
Metal Vents	30
Air Deflectors	31
Accessories	31

Vents

Aluminium Mushroom Roof Cowl	33
External Stainless Steel	33-35
External Plastic Vents	36-37
Door Grilles	38
Multi-Directional Outlets & Adaptors	39-40
Return Air Grilles	41

Ducting & Accessories

Roof Accessories	43
Semi Rigid Ducting	44
Flexible Ducting	44
Insulated Ducting	45
Duct Connectors	46-48
Accessories	49

Index



DEFLECTO, A NAME RECOGNISED AROUND THE WORLD

Our Promise To You:



Customer Service

We provide exceptional customer service with expert industry knowledge and experience.



Expert Knowledge

Having a wide range of ventilation products, we pride ourselves on our extensive range of industry knowledge and technical material.



Sell The Best

Our products have been designed using high-quality, innovative and cost-effective materials.



Fast & Secure Delivery

Using the best freight services in Australia, you can expect trackable, secure and rapid delivery on your purchase.

What are the benefits of ventilation my home?

Our venting kits help decrease the risk of fire and vermin, control moisture residue and encourage fresh air into the home.

This creates a more comfortable, energy-efficient, and healthier environment for you and your loved ones.

Does your ducting comply with Australian Standards?

Yes, we comply with the following Australian Standards:

Semi Rigid Ducting:

- Australian & New Zealand Standards AS43826
- 4-Zero fire rating to Australian Standards AS150.3

Flexible Ducting:

- Australian Standards AS1688.1
- 4-Zero fire rating to Australian Standards AS150.3

Rectangular Ducting:

- BCA vol 1 with reference to AUS/NZ Standards AS 4254-1995

Insulated Ducting:

- Australian & New Zealand Standards AS/NZS 4859.1

Where can I find Technical/Specification Sheets for your products?

We have a wide range of Technical Sheets on our products. You can find our Specification Sheets can on our website:

www.ventilation.jpbrands.com.au/spec-sheets

Do your Vents comply with a Bushfire Attack Level?

Our Mushroom Roof Cowls, Dome, Eave, Hooded, Gravity and Fixed Louvre Stainless Steel vents all comply with **BAL40 (Bushfire Attack Level)** when supplied cinder mesh insert is used with the outlet.

Look out for this icon:



What diameter do your rangehood ventilation products come in?

Our rangehood ventilation products come in 100mm, 125mm, 150mm and 200mm Anything larger than 200mm is considered to be commercial ventilation.

What are the turnaround times for orders?

Destination	ETA
VIC	1 - 2 Business Days
NSW Metro	1 - 2 Business Days
ACT	3 - 4 Business Days
SA Metro	1 - 2 Business Days
QLD Metro	2 - 3 Business Days
WA Metro	4 - 5 Business Days
TAS	4 - 5 Business Days

For More Information Please Visit
Our Website: www.jpbrands.com.au



Rangehood Venting

With a wide range of kits and components, our Rangehood Ventilation range will suit most installations.



Roof Venting Kits

Efficiently expel unwanted fumes and odours from your rangehood through the roof via a mushroom cowl.

Features

- Complies to Australian and New Zealand Standards: AS43826
- Superior temperature rating of -70°C to +200°C
- Semi Rigid Ducting keeps its shape when formed into place
- Modern mushroom cowl provides greater protection from birds, rain and rust

Extra Information

- Extend reach with additional duct, sleeve and clamps (see pages 40-45)
- Installation by a professional is recommended

PLEASE NOTE: Kits On Page 5 Are Not Supplied With Roof Specific Flashing (See Page 39)



Rangehood Roof Venting Kit - 125mm

Components:

- RMC5M - Roof Mushroom Cowl with Mesh (125mm)
- GSPS052430 - Deflecto Clip-Seam Pipe (125mm x 610mm)
- AO503M - Deflecto Semi Rigid Duct (125mm x 3M)
- MC5/2 - Deflecto Worm Drive Duct Clamp (125mm) 2 Pack
- BRACE - Galvanised Steel Bracing Strap (1M)
- Rivets & Drill Bits

Model No.	Product	Diameter (mm)	Outlet
RHK125T	Rangehood Vent Kit - Roof	125mm	Aluminium

Rangehood Roof Venting Kit - 150mm

Components:

- RMC6M - Roof Mushroom Cowl with Mesh (150mm)
- GSPS062430 - Deflecto Clip-Seam Pipe (150mm x 610mm)
- AO603M - Deflecto Semi Rigid Duct (150mm x 3M)
- MC6/2 - Deflecto Worm Drive Duct Clamp (150mm) 2 Pack
- BRACE - Galvanised Steel Bracing Strap (1M)
- Rivets & Drill Bits

Model No.	Product	Diameter (mm)	Outlet
RHK150T	Rangehood Vent Kit - Roof	150mm	Aluminium

Rangehood Roof Venting Kit - 200mm

Components:

- RMC8M - Roof Mushroom Cowl with Mesh (200mm)
- GSPS082430 - Deflecto Clip-Seam Pipe (200mm x 610mm)
- AO803M - Deflecto Semi Rigid Duct (200mm x 3M)
- MC8/2 - Deflecto Worm Drive Duct Clamp (200mm) 2 Pack
- BRACE - Galvanised Steel Bracing Strap (1M)
- Rivets & Drill Bits

Model No.	Product	Diameter (mm)	Outlet
RHK200T	Rangehood Vent Kit - Roof	200mm	Aluminium

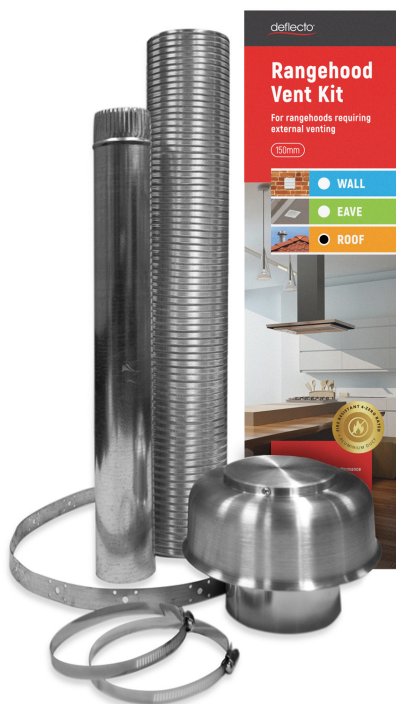

Eave Venting Kits

Externally vent your rangehood through the ceiling and out the eave using either a plastic or stainless steel vent.

Features

- Complies to Australian and New Zealand Standards: AS43826
- Superior temperature rating of -70°C to +200°C
- Semi Rigid Ducting keeps its shape when formed into place
- UV stabilised plastic grille vent with removable front grille and mesh for easy cleaning
- ONLY the Stainless Steel Eave vents **complies with BAL40 (Bushfire Attack Level)**, when used with supplied cinder mesh insert

Extra Information

- Extend reach with additional duct, sleeve and clamps (see pages 40-45)
- Installation by a professional is recommended

Rangehood Eave Venting Kit - 125mm

Components:

- HGV5 - Deflecto Grille Vent with Screen (125mm) **OR** EVSS125 - Eave Vent Stainless Steel with Mesh (125mm)
- AO503M - Deflecto Semi Rigid Duct (125mm x 3M)
- MC5/2 - Deflecto Worm Drive Duct Clamp (125mm) 2 Pack

Model No.	Product	Diameter (mm)	Outlet
RHK125E	Rangehood Vent Kit - Eave	125	Plastic
RHK125ESS	Rangehood Vent Kit - Eave	125	Stainless Steel



Rangehood Eave Venting Kit - 150mm

Components:

- HGV6 - Deflecto Grille Vent with Screen (150mm) **OR** EVSS150 - Eave Vent Stainless Steel with Mesh (150mm)
- AO603M - Deflecto Semi Rigid Duct (150mm x 3M)
- MC6/2 - Deflecto Worm Drive Duct Clamp (150mm) 2 Pack

Model No.	Product	Diameter (mm)	Outlet
RHK150E	Rangehood Vent Kit - Eave	150	Plastic
RHK150ESS	Rangehood Vent Kit - Eave	150	Stainless Steel

Rangehood Eave Venting Kit - 200mm

Components:

- HGV8 - Deflecto Grille Vent with Screen (200mm) **OR** EVSS200B - Eave Vent Stainless Steel with Mesh (200mm)
- AO803M - Deflecto Semi Rigid Duct (200mm x 3M)
- MC8/2 - Deflecto Worm Drive Duct Clamp (200mm) 2 Pack

Model No.	Product	Diameter (mm)	Outlet
RHK200E	Rangehood Vent Kit - Eave	200	Plastic
RHK200ESS	Rangehood Vent Kit - Eave	200	Stainless Steel



Wall Venting Kits

Externally vent your rangehood through the ceiling and out the wall using either a gravity louvred plastic or stainless steel vent.

Features

- Complies to Australian and New Zealand Standards: AS43826 & 4-Zero fire rating to AS150
- Superior temperature rating of -70°C to +200°C
- Semi Rigid Ducting does not lose shape when bent into place
- UV stabilised polypropylene plastic louvred vent
- ONLY the Stainless Steel Wall vents **complies with BAL40 (Bushfire Attack Level)**, when used with supplied cinder mesh insert

Extra Information

- Extend reach with additional duct, sleeve and clamps (see pages 40-45)
- Installation by a professional is recommended



Rangehood Wall Venting Kit - 125mm

Components:

- HSR5W - Deflecto Gravity Wall Vent (125mm) **OR** GVSS125 - Gravity Wall Vent Stainless Steel with Mesh (125mm)
- AO503M - Deflecto Semi Rigid Duct (125mm x 3M)
- MC5/2 - Deflecto Worm Drive Duct Clamp (125mm) 2 Pack

Model No.	Product	Diameter (mm)	Outlet
RHK125W	Rangehood Vent Kit - Wall	125	Plastic
RHK125WSS	Rangehood Vent Kit - Wall	125	Stainless Steel

Rangehood Wall Venting Kit - 150mm

Components:

- HSR6W - Deflecto Gravity Wall Vent (150mm) **OR** GVSS150 - Gravity Wall Vent Stainless Steel with Mesh (150mm)
- AO603M - Deflecto Semi Rigid Duct (150mm x 3M)
- MC6/2 - Deflecto Worm Drive Duct Clamp (150mm) 2 Pack

Model No.	Product	Diameter (mm)	Outlet
RHK150W	Rangehood Vent Kit - Wall	150	Plastic
RHK150WSS	Rangehood Vent Kit - Wall	150	Stainless Steel

Rangehood Wall Venting Kit - 200mm

Components:

- HS8W - Deflecto Gravity Wall Vent (200mm) **OR** GVSS200B - Gravity Wall Vent Stainless Steel (200mm)
- AO803M - Deflecto Semi Rigid Duct (200mm x 3M)
- MC8/2 - Deflecto Worm Drive Duct Clamp (200mm) 2 Pack

Model No.	Product	Diameter (mm)	Outlet
RHK200W	Rangehood Vent Kit - Wall	200	Plastic
RHK200WSS	Rangehood Vent Kit - Wall	200	Stainless Steel





Universal Venting Kits: Roof

The universal venting kits are ideal for single ventilation requirements that have both 125 & 150mm outlets.

(E.g. 125mm rangehood & a 150mm outlet through the roof)

Features

- Complies to Australian and New Zealand Standards: AS43826 & 4-Zero fire rating to AS150.3
- Superior temperature rating of -70°C to +200°C
- Includes 125 to 150mm duct increaser/decreaser
- Roof specific flashing included in the kits
- Semi Rigid Ducting does not lose shape when bent into place
- The Mushroom Cowl provides greater protection from birds, rain and rust

Extra Information

- Extend reach with additional duct, sleeve and clamps (see pages 40-45)
- Installation by a professional is recommended

Universal Rangehood Metal Roof Kit

Components:

- RMC6M - Roof Mushroom Cowl with Mesh (150mm)
- GSPS062430 - Deflecto Clip-Seam Pipe (150mm x 610mm)
- KFM36 - Kensington Flashing Metal Roof (76mm - 150mm)
- AO603M - Deflecto Semi Rigid Duct (150mm x 3M)
- A0503M - Deflecto Semi Rigid Duct (125mm x 30cm)
- DIRB65 - Deflecto Duct Increaser/Reducer (125mm to 150mm)
- MC6/2 - Deflecto Worm Drive Duct Clamp (150mm) 2 Pack
- MC5/2 - Deflecto Worm Drive Duct Clamp (125mm) 2 Pack
- LDE30 - Lancaster D/Ended Panel Drill & Rivets
- BRACE - Galvanised Steel Bracing Strap (1M)

Model No.	Product	Diameter (mm)	Outlet
RHKMR65	Universal Rangehood Vent Kit - Metal	125 & 150	Roof



Universal Rangehood Tile Roof Kit

Components:

- RMC6M - Roof Mushroom Cowl with Mesh (150mm)
- GSPS062430 - Deflecto Clip-Seam Pipe (150mm x 610mm)
- KFT38 - Kensington Flashing Tile Roof (76mm - 203mm)
- AO603M - Deflecto Semi Rigid Duct (150mm x 3M)
- A0503M - Deflecto Semi Rigid Duct (125mm x 30cm)
- DIRB65 - Deflecto Duct Increaser/Reducer (125mm to 150mm)
- MC6/2 - Deflecto Worm Drive Duct Clamp (150mm) 2 Pack
- MC5/2 - Deflecto Worm Drive Duct Clamp (125mm) 2 Pack
- LDE30 - Lancaster D/Ended Panel Drill & Rivets
- BRACE - Galvanised Steel Bracing Strap (1M)

Model No.	Product	Diameter (mm)	Outlet
RHKTR65	Universal Rangehood Vent Kit - Tile	125 & 150	Roof



Universal Venting Kit: Wall & Eave

The Universal Wall/Eave Rangehood Kit is ideal for single ventilation requirements that have both 125 & 150mm outlets.

(E.g. 125mm rangehood & a 150mm wall/eave outlet or vice-versa)

Features

- Complies to Australian and New Zealand Standards: AS43826 & 4-Zero fire rating to AS150.3
- Superior temperature rating of -70°C to +200°C
- Includes 125 to 150mm duct increaser/decreaser
- UV stabilised plastic grille vent with removable front grille and mesh for easy cleaning
- Semi Rigid Ducting does not lose shape when formed into place

Extra Information

- Extend reach with additional duct, sleeve and clamps (see pages 40-45)
- Installation by a professional is recommended



Universal Wall/Eave Rangehood Kit

Components:

- HGV6 - Deflecto Grille Vent with Screen (150mm)
- AO603M - Deflecto Semi Rigid Duct (150mm x 3M)
- A0503M - Deflecto Semi Rigid Duct (125mm x 30cm)
- DIRB65 - Deflecto Duct Increaser/Reducer (125mm to 150mm)
- MC6/2 - Deflecto Worm Drive Duct Clamp (150mm) 2 Pack
- MC5/2 - Deflecto Worm Drive Duct Clamp (125mm) 2 Pack

Model No.	Product	Diameter (mm)	Ducting
RHKE65	Universal R/Hood Kit - Wall/Eave	125 & 150	Semi Rigid Aluminium

Rangehood Rectangular to Round Adaptor

- Suit rectangular outlets 130mm (W) x 290mm (D) or less
- Full aluminium construction for maximum fire and corrosion protection
- Alcohol wipe for surface cleaning prior to attachment
- Fire retardant/heat resistant adhesive included

Model No.	Product	Diameter (mm)	Dimensions W x H x D (mm)	Carton Qty
RHA5	R/Hood Adaptor	125	130 x 110 x 290	12



Rangehood Flange Adaptor

- Made from Galvanised Steel for maximum fire protection
- Two options available for 125 & 150mm outlets
- Alcohol wipe for surface cleaning prior to attachment
- Fire retardant/heat resistant adhesive ring

Model No.	Product	Diameter (mm)	Dimensions	Carton Qty
RHF5R	Flange Adapt 125mm	125	13mm flange x 50mm (H)	1
RHF6R	Flange Adapt 150mm	150	13mm flange x 50mm (H)	1



RHF5R

Rectangular Ducting

This range offers a low profile rectangular ducting alternative to standard round aluminium ducting and is ideal for installations with minimal space allowances.

Features

- Light-weight self-extinguishing PVC complies with BCA vol 1 with reference to AUS/NZ standards AS4254-1995
- 204 x 60mm replacement for 125-150mm round ducting
- Modular components slide together for easier installation
- White ducting that can be painted to blend in with existing decor

Rectangular Flat Duct

- Flat pack channel duct piece

Model No.	Product	Carton Qty
FD2001	Flat-pack Duct - 1M	1
FD2002	Flat-pack Duct - 2M	1



PLEASE NOTE: Due to the Length of FD2002, This Item Will Incur Freight Manual Handling Charges

45° Horizontal Bend

- Connects to a channel duct and re-directs air at a 45° angle

Model No.	Product	Carton Qty
FD2004	45° Horizontal Bend	1

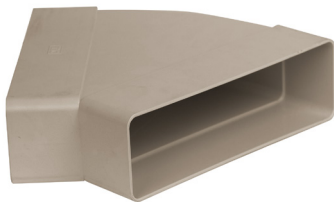

Rectangular Duct Connector

- Connects two rectangular duct pieces for extended length

Model No.	Product	Carton Qty
FD2003	Duct Connector	1



90° Horizontal Bend

- Connects to channel duct and re-directs air at a right angle

Model No.	Product	Carton Qty
FD2005	90° Horizontal Bend	1

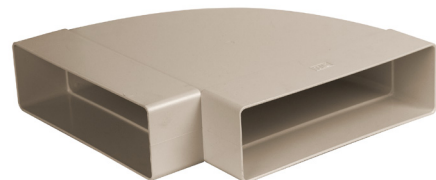

45° Vertical Bend

- Connects to a channel duct and re-directs air at a 45° angle

Model No.	Product	Carton Qty
FD2006	45° Vertical Bend	1



Horizontal T-Piece

- Connects to channel duct and re-directs air

Model No.	Product	Carton Qty
FD2008	Horizontal T-Piece	1

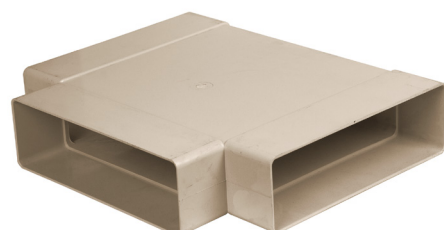

90° Bend Spigot Adaptor

- 150mm spigot for optional offset attachment of round vertical pipe or ducting
- Dimensions: 204mm x 60mm, 150mm Diameter

Model No.	Product	Carton Qty
FD2009	150mm 90° Fixed Bend	1

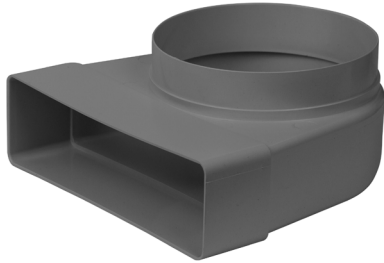

Round to Flat Straight Adaptor

- Connects to 125mm round outlets and converts to channel duct

Model No.	Product	Carton Qty
FD2010	Rnd - Flat Apt.	1



Flat Duct Wall Plate

- Covers any imperfections from the cut-out in the wall or ceiling
- Provides an attractive finish to the ventilation system.

Model No.	Product	Carton Qty
FD2011	Wall Plate	1

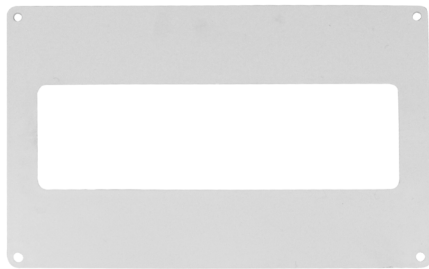

Flat Duct Clip

- Secures ducting to the wall or ceiling
- Simply screw the clip in then click the ducting into place

Model No.	Product	Carton Qty
FD2012	Flat Duct Clip (Plastic)	1
FD2013	Flat Duct Clip (Metal)	1

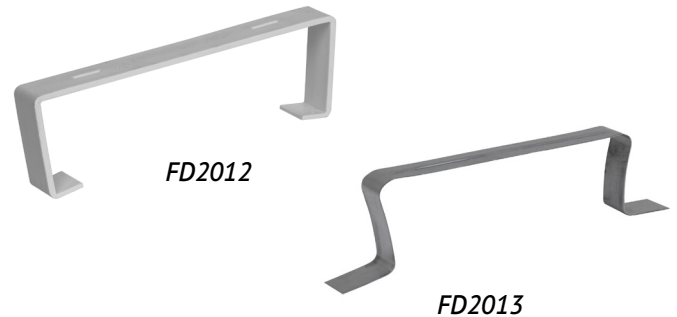

Circular Reducer/Expander

- Connects to rangehood outlet and reduces/expands diameter for attachment of elbow bend or circular ducting

Model No.	Product	Joins (mm)	Material	Carton Qty
FD2014	Circular Reducer/Expander	100 - 125	Plastic	1
FD2015	Circular Reducer/Expander	100 - 150	Plastic	1
FD2016	Circular Reducer/Expander	125 - 150	Plastic	1
FD2017	Circular Reducer/Expander	150 - 200	Plastic	1



FD2014

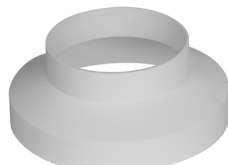

FD2015



FD2016



FD2017

Dryer Venting

Allow heat and moisture to exhaust out of your home with our extensive range of dryer kits and components.

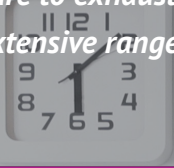

Dryer Venting System (DVS)

Deflecto clothes dryer venting solutions are engineered for health, safety and energy efficiency. Clothes dryer venting removes lint, moisture and mildew from building up. This reduces structural damage, the risk of fire and keeps your home cleaner.

Further benefits include decreased electricity usage as drying times are quicker and more efficient.

PLEASE NOTE: Clothes dryer ventilation kits & components have a diameter of 100mm suiting most current dryer models and applications.



Inlet/Outlet Kit

Ideal for dryers backing onto an external wall.

Features:

- Offers 360° installation option that fits under wall bracket
- 275mm inlet/outlet centre to centre reach

Components:

- DVSI - Deflecto Dryer Vent Sys. - Inlet Duct
 - DVSWO - Deflecto Dryer Vent Sys. - Wall Outlet
 - DVSTP - Deflecto Dryer Vent Sys. - Tape Discs
 - DVSSC - Deflecto Dryer Vent Sys. - Saddle Clamp
 - DVSGR - Deflecto Dryer Vent Sys. - Gasket Ring
 - 361TAPE - Cloth Tape
- Includes double sided adhesive pads for wall mount option.

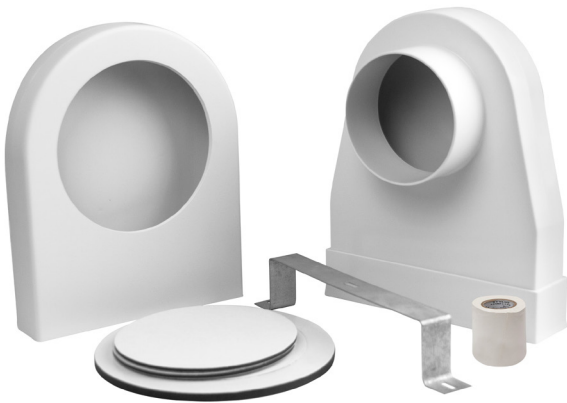

Model No.	Product	Diameter (mm)
DVS2	Dryer Vent Sys. - Inlet/Outlet Kit	100

May Be Extended Using DVS Components (Pages 16-17) And Vented Outside Using A DVS1 - Through The Wall Kit (Page 14)

Rectangular to Round Kit

This kit reaches the nearest edge of the dryer, where it is continued via flexible duct and any DVS external ducting option.

Features:

- Top, side or bottom installation options
- 275mm reach from inlet centre to machine's edge

Components:

- DVSI - Deflecto Dryer Vent Sys. - Inlet Duct
 - DVSE - Deflecto Dryer Vent Sys. - Elbow (45°)
 - DVSO - Deflecto Dryer Vent Sys. - Outlet
 - DVSSC - Deflecto Dryer Vent Sys. - Saddle Clamp
 - DVSGR - Deflecto Dryer Vent Sys. - Gasket Ring
 - 361TAPE - Cloth Tape
- Includes double sided adhesive pads for wall mount option.



Model No.	Product
DVS3	Dryer Vent Sys. - Inlet/Outlet Kit

Through the Wall Kit

Accepts dryer exhaust from in-laundry ducting option and vents outside.

Features:

- Used in conjunction with an in-laundry ducting option
- Back-flow control eliminates the entry of birds and vermin
- The wall plate also accepts DVSWO (waste outlet)

Components:

- DVSWP - Deflecto Dryer Vent Sys. - Wall Plate (with Plug)
- HSR4W - Deflecto Gravity Wall Vent (100mm) **OR**
- GVSS100 - Gravity Wall Vent Stainless Steel with Mesh (100mm)
- DP411S - Deflecto Aluminium Clip-Seam Pipe (100mm x 280mm)

Model No.	Product	Diameter (mm)
DVS1	Dryer Vent Sys. - Wall Kit (Plastic)	100
DVS1SS	Dryer Vent Sys. - Wall Kit (Stainless Steel)	100



DVS1



DVS1SS

Corner Duct Kit

Suits dryers positioned on an internal wall that need to navigate around a 90° corner to ventilate outside through a secondary wall, eave or roof.

Features:

- Top, side or bottom installation options
- 275mm reach from inlet centre to machine's edge
- 1250mm maximum reach from inlet centre to wall corner
- Use with DVS1 to vent the dryer outside through an external wall
- Use with DVS4 to vent the dryer outside via the eave
- Use with DVS6 to vent the dryer outside via the ceiling

Components:

- DVSI - Deflecto Dryer Vent Sys. - Inlet Duct
- DVSE - Deflecto Dryer Vent Sys. - Elbow (45°)
- DVSC - Deflecto Dryer Vent Sys. - Corner Duct
- DVSWO - Deflecto Dryer Vent Sys. - Wall Outlet
- DVSD - Deflecto Dryer Vent Sys. - Duct (x3)
- DVSSC - Deflecto Dryer Vent Sys. - Saddle Clamp
- DVSGR - Deflecto Dryer Vent Sys. - Gasket Ring
- 361TAPE - Cloth Tape

Model No.	Product	Diameter (mm)
DVS5	Dryer Vent Sys. - Corner Duct	100

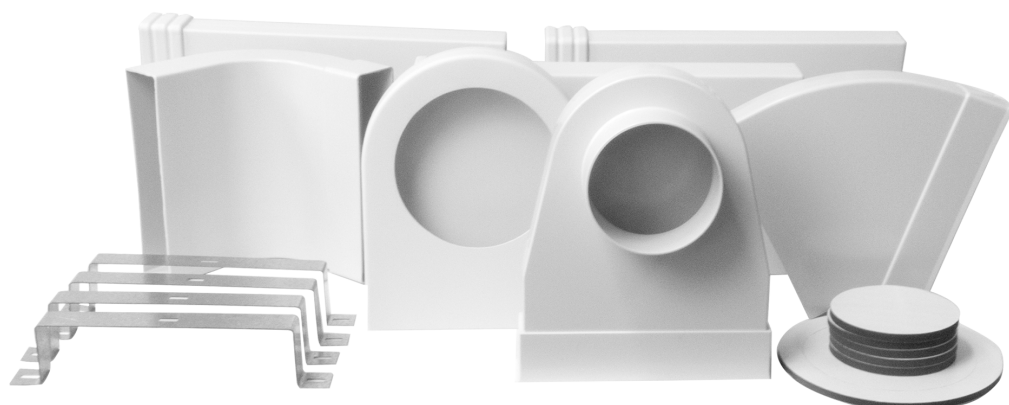

The centre of the dryer's outlet must be within 160mm of the dryer's edge

Accepts dryer exhaust from in-laundry ducting option and securely vents outside.



DVS4 & DVS6



Ceiling to Eave Kit

Accepts dryer exhaust from in-laundry ducting option and securely vents outside.

Features:

- Back-flow control eliminates the entry of birds and vermin
- DVSWP Wall plate accepts DVSWO (wall outlet)
- Offers 2.7 metre reach from ceiling outlet to eave

Components:

- DVSWP - Deflecto Dryer Vent Sys. - Wall Plate (with Plug)
- EVE - Deflecto Under-Eave Vent (75mm - 125mm)
- AO403M - Deflecto Semi Rigid Duct (100mm x 3M)
- MC4/2 - Deflecto Worm Drive Duct Clamp (100mm) 2 Pack

Model No.	Product	Diameter (mm)
DVS4	Dryer Vent Sys. - Eave	100



Ceiling to Roof Kit

Accepts dryer exhaust from in-laundry ducting option and vents outside through the roof via a mushroom cowl (roof specific flashing sold separately see page 39).

Features:

- Includes a rectangular to round diverter that fits under a standard wall mounting bracket for side/top venting
- Wall Plate accepts DVSWO (low profile duct) as a push-fit 3 metre reach from ceiling outlet to roof

Components:

- DVSWP - Deflecto Dryer Vent Sys. - Wall Plate (with Plug)
- RMC4M - Roof Mushroom Cowl with Mesh (100mm)
- AO403M - Deflecto Semi Rigid Duct (100mm x 3M)
- GSPS042430 - Deflecto Clip-Seam Pipe (100mm x 610mm)
- BRACE - Galvanised Steel Bracing Strap (1M)
- MC4/2 - Deflecto Worm Drive Duct Clamp (100mm) 2 Pack

Model No.	Product	Diameter (mm)
DVS6	Dryer Vent Sys. - Roof	100

The centre of the dryer's outlet must be within 160mm of the dryer's edge

DVS - Low Profile Corner Duct

Extends a low profile ducting system around an internal corner and navigates air from wall to wall, or wall to ceiling.

- Flame retardant, self-extinguishing plastic
- Lightly sand and paint to match laundry decor
- Extends 160mm on either side of a corner

Model No.	Product	External Size (mm)
DVSC	DVS. - Corner Duct	195 (W) x 47 (D)



DVS - Low Profile Extension Duct

Extends a low profile ducting system by 300mm. Designed to fit between the dryer and a standard wall mounting bracket.

- Flame retardant, self-extinguishing plastic
- Lightly sand and paint to match laundry decor

Model No.	Product	External Size (mm)
DVSD	DVS. - Extension Duct	195 (W) x 340 (L) x 47 (D)



DVS - Low Profile Inlet Duct

Connects to dryers with a flush, rear outlet via an adhesive gasket to begin a rectangular ducting system that fits between the dryer and a standard wall mounting bracket

- Flame retardant, self-extinguishing plastic

Model No.	Product	External Size (mm)
DVSI	DVS. - Inlet Duct	95 (W) x 240 (L) x 47 (D)

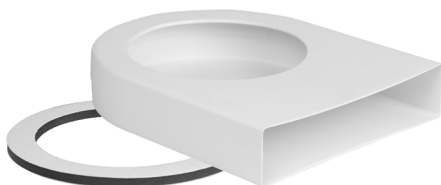

DVS - Self Adhesive Gasket Ring

DVSGR is a double-sided heat resistant self-adhesive ring for attached DVSI or DVSU around the dryer outlet or vent. 361TAPE provides an extra level of security between DVS system components.

Model No.	Product	External Size (mm)
DVSGR	DVS. - Gasket Ring	175/135 x 7



DVS - 45° Elbow Duct

Extends the DVS ducting system at a 45° angle. Designed to fit between the dryer and a standard wall mounting bracket.

Model No.	Product	External Size (mm)
DVSE	DVS. - Elbow	195 (W) x 235 (L) x 47 (D)



DVS - Low Profile Outlet - 100mm

Converts low profile ducting to a 100mm round outlet for the connection of fire-rated, flexible ducting. Designed to fit on the edge of the dryer.

- Flame retardant, self-extinguishing plastic

Model No.	Product	External Size (mm)
DVSO	DVS. - Outlet	195 (W) x 175 (L) x 47 (D)



DVS - Saddle Clamp

Galvanised for corrosion protection, this saddle clamp helps to secure the 190mm width of the DVSI - inlet duct to the outlet on the back of the dryer, or when DVS components are mounted on a wall or ceiling surface.

- 3 Screw slots for attachment
- 2 x 23mm Lugs on either end

Model No.	Product	External Size (mm)
DVSSC	DVS. - Saddle Clamp	25 (W) x 190 (L)



DVS - USA Style Adaptor Cone

When attached to a DVSI - Inlet duct, the DVSU acts as a female inlet connection to accept the dryer's exhaust from appliances with male rear, and spigot-type outlets.

- Internal cone diameter tapers from 104mm front to 99mm rear

Model No.	Product	External Diameter
DVSU	DVS. - USA Adaptor	175mm rear flange



DVS - Low Profile Waste Inlet

Designed to adapt dryer outlets with a 100mm internal cavity diameter to a rectangular ducting system.

- Flame retardant, self extinguishing plastic
- Internal cone diameter tapers from 104mm front to 99mm rear

Model No.	Product	External Size (mm)
DVSWI	DVS. - Waste Inlet	190 (W) x 200 (L) x 43 (D)

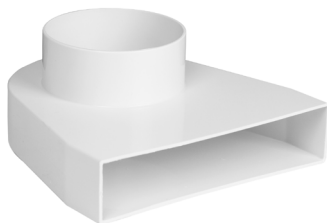

DVS - Low Profile Waste Outlet

Designed to plug into the DVSWP - Wall Plate to continue outside through an external ducting kit option. Female end accepts regular DVS components.

- Flame retardant, self-extinguishing plastic
- 100mm x 40mm spigot

Model No.	Product	External Size (mm)
DVSWO	DVS. - Waste Outlet	195 (W) x 240 (L) x 47 (D)

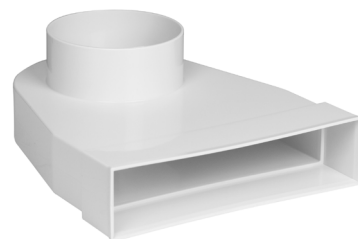

DVS - Wall Plate/Plug

Flush fitting wall or ceiling plate, the DVSWP accepts the DVSWO - wall outlet using the low profile ducting.

- Plug

Model No.	Product	Outer Flange	Carton Qty
DVSWP	DVS. - Wall Plate/Plug	101mm	1



Dryer Back Adaptor Kit

Suited for dryers with a round outlet, the dryer back adaptor kit adheres to the back of the machine using a double-sided adhesive gasket ring.

- The kit allows for the attachment of external venting options
- GR4 - Double sided self adhesive gasket ring

Model No.	Product	Outer Flange	Carton Qty
DB4K	Dryer Back Adaptor Kit	101mm	1



Dryer Diverter Assembly

Use on rear vented dryers where the centre of the outlet is within 160mm of the edge of the machine. Transfers into a 100mm round outlet for attaching flexible ducting. Fits under a standard wall mounting bracket for side/top venting.



Components:

- DS4 - Deflecto Saddle Clamp - Dryer Divertor
- DV4 - Deflecto Dryer Vent Diverter Pipe
- GR4 - Deflecto DV4 Gasket Ring

Model No.	Product	Dimensions (mm)	Carton Qty
DV4A	Dryer Diverter Assembly	150 (W) x 350 (L) x 42 (D)	1

Dryer Internal Lint Trap

Fits directly onto dryers with a rear spigot-type outlet. Features a uniquely designed water bath trap where the fine lint missed by the dryer filter is collected on the water surface. Combine with DVS3 or DV4A diverter kits for dryers with flush outlet hole.

Components:

- LTF - Deflecto Dryer Intern Lint Trap C/W Duct
- FO4 - Deflecto Supurr-Flex Duct (100mm x 1M)
- CB34 - Plastic Cable Ties (x2)



Model No.	Product	Carton Qty
LTF	Dryer Internal Lint Trap	1

Dryer Lint Trap with Dryer Diverter Assembly

A combination of the dryer diverter assembly and the dryer internal lint trap kits (above). Complete with a rear diverter pipe, it also transfers into a 100mm round outlet for attaching flexible ducting using a uniquely designed water bath trap.



Components:

- LTF - Deflecto Dryer Intern Lint Trap C/W Duct
- FO4 - Deflecto Supurr-Flex Duct (100mm x 1M)
- DV4A - Deflecto Dryer Diverter Assembly
- CB34 - Plastic Cable Ties (x2)

Model No.	Product	Carton Qty
LTKA	Dryer Lint Trap W/Dryer Diverter Assembly	1

Universal Through the Wall Kit

Designed to rear vent a dryer through an outside wall, this kit includes a rectangular to round diverter that fits under a standard wall mounting bracket for side/top venting.

Components:

- HS4WJ - Deflecto Gravity Wall Vent - Suits Solid Flange Duct (100mm)
- DP411S - Deflecto Aluminium Clip-Seam Pipe (100mm x 280mm)
- FO408B - Deflecto Supurr-Flex Duct (100mm X 2.4M)
- DV4A - Deflecto Dryer Diverter Assembly
- CB34 - Plastic Cable Ties (x2)

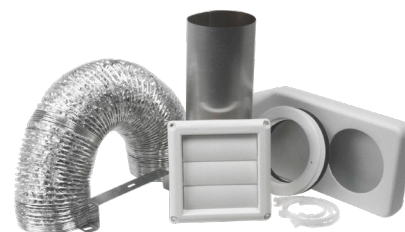

Model No.	Product	Outlet	Carton Qty
DK4W	Universal Through the Wall Kit	Wall	6

The Centre of the dryer's outlet must be within 160mm of the dryer's edge with DV4A

All Fisher & Paykel Dryer Ventilation Kits are specifically designed for Fisher & Paykel Dryers. Clothes dryer ventilation components have a diameter of 100mm suiting most current dryer models.

Fisher & Paykel Dryer Vent Kit - Wall

This kit is ideal for dryers backing onto an external wall.

Components:

- DVSFP - Deflecto Dryer Vent Outlet **(F&P)**
- DVSD - Deflecto Dryer Vent Sys. - Duct
- DVSWO - Deflecto Dryer Vent Sys. - Wall Outlet
- GR4 - Deflecto DV4 Gasket Ring
- 361TAPE - Cloth Tape

Model No.	Product	Outlet	Carton Qty
DVKFPW	Dryer Vent Kit - Wall	Wall	1

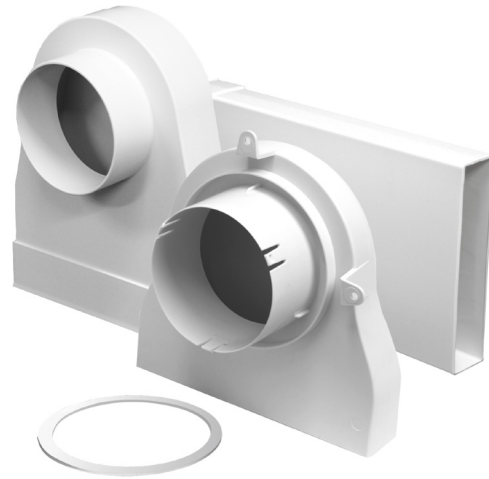

Fisher & Paykel Dryer Vent Kit - Short

This kit reaches the nearest edge of the dryer where you can continue to duct using FO408B Flexible Ducting.

Components:

- DVSFP - Deflecto Dryer Vent Outlet **(F&P)**
- DVSE - Deflecto Dryer Vent Sys. - Elbow (45°)
- DVSO - Deflecto Dryer Vent Sys. - Outlet
- GR4 - Deflecto DV4 Gasket Ring
- 361TAPE - Cloth Tape

Model No.	Product	Outlet	Carton Qty
DVKFPS	Dryer Vent Kit - Short	Wall	1

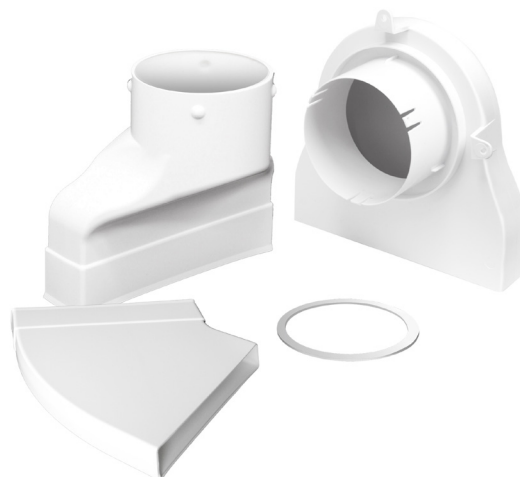

Fisher & Paykel Dryer Vent Kit - Long

This kit reaches the longest edge of the dryer where you can continue to vent using FO408B Flexible Ducting.

Components:

- DVSFP - Deflecto Dryer Vent Outlet **(F&P)**
- DVSE - Deflecto Dryer Vent Sys. - Elbow (45°)
- DVSD - Deflecto Dryer Vent Sys. - Duct (x2)
- DVSO - Deflecto Dryer Vent Sys. - Outlet
- GR4 - Deflecto DV4 Gasket Ring
- 361TAPE - Cloth Tape

Model No.	Product	Outlet	Carton Qty
DVKFPL	Dryer Vent Kit - Long	Wall	1

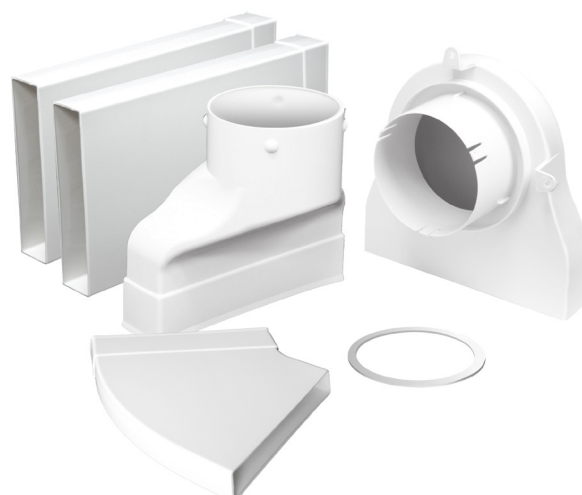

Air Transfer

With a wide range of kits and fans, protect your home from moist and odours.



COMPLETE YOUR HOME WITH OUR

ALL-IN-ONE CEILING EXHAUST FAN KITS

NEW



Our Ceiling Exhaust Fan Kits

New from Deflecto, the Ceiling Exhaust Fan Kits will efficiently extract fumes and air from your bathroom/kitchen through either the wall, roof or eave cavity, providing superior ventilation and comfort in your home or workplace.

- ✓ Designed to exhaust and reduce unwanted mould and moisture.
- ✓ Exhaust Fans have whisper-quiet ball-bearing motors.
- ✓ Both Exhaust Fans have a built in Draft Blocker.
- ✓ Efficiently exhaust with our Standard Fan rated at 270 m³/hr or the Quiet Boost Fan rated at 400 m³/hr.

Available for Wall, Eave, Metal and Tile Roof ventilation applications.
Complies with all NCC and AS/NZS Standards.

2 YEAR
WARRANTY

FOR CEILING
EXHAUST FANS

Scan For More
Information



STANDARD EXHAUST FAN

The Standard Ceiling Exhaust Fan is an all in one exhaust fan with an outstanding performance, capacity and sound. The Standard Fan is rated 270³m/hr and will efficiently expell unwanted mositure and odours outside via the ducting and exhaust vent.

NEW



Ceiling Exhaust Fan Standard Wall/ Eave Kit

Components:

- EFLP200 - Ceiling Exhaust-Fan (200mm)
- HGV6 - Deflecto Grille Vent with Screen (150mm)
- FO603M - Deflecto Supurr-Flex Duct (150mm x 3.6M)
- MC6/2 - Deflecto Worm Drive Duct Clamp (150mm) 2 Pack

Model No.	Product
-----------	---------

CEF200WE	Deflecto Standard Ceiling Exhaust Fan - Wall/Eave Kit
----------	---



Ceiling Exhaust Fan Standard Metal Roof Kit

Components:

- EFLP200 - Ceiling Exhaust-Fan (200mm)
- RMC6M - Roof Mushroom Cowl with Mesh (150mm)
- GSPS062430 - Deflecto Clip-Seam Pipe (150mm x 610mm)
- KFM36 - Kensington Flashing Metal Roof (76mm - 150mm)
- FO603M - Deflecto Supurr-Flex Duct (150mm x 3.6M)
- MC6/2 - Deflecto Worm Drive Duct Clamp (150mm) 2 Pack
- BRACE - Galvanised Steel Bracing Strap (1M)
- Rivets & Drill Bits

Model No.	Product
-----------	---------

CEF200MR	Deflecto Standard Ceiling Exhaust Fan - Metal Roof Kit
----------	--



Ceiling Exhaust Fan Standard Tile Roof Kit

Components:

- EFLP200 - Ceiling Exhaust-Fan (200mm)
- RMC6M - Roof Mushroom Cowl with Mesh (150mm)
- GSPS062430 - Deflecto Clip-Seam Pipe (150mm x 610mm)
- KFT38 - Kensington Flashing Tile Roof (76mm - 203mm)
- FO603M - Deflecto Supurr-Flex Duct (150mm x 3.6M)
- MC6/2 - Deflecto Worm Drive Duct Clamp (150mm) 2 Pack
- BRACE - Galvanised Steel Bracing Strap (1M)
- Rivets & Drill Bits

Model No.	Product
-----------	---------

CEF200TR	Deflecto Standard Ceiling Exhaust Fan - Tile Roof Kit
----------	---

QB EXHAUST FAN

Offering itself as a premium alternative, the Quiet Boost or “QB” Ceiling Exhaust Fan is as powerful as it is quiet. The QB Fan is rated 400³m/hr and will efficiently expell unwanted mositure and odours outside via the ducting and exhaust vent.

NEW



Ceiling Exhaust Fan Quiet Boost “QB” Wall/ Eave Kit

Components:

- EFLQ250 - Quiet Boost Ceiling Exhaust-Fan (250mm)
- HG6 - Deflecto Grille Vent with Screen (150mm)
- FO603M - Deflecto Supurr-Flex Duct (150mm x 3.6M)
- MC6/2 - Deflecto Worm Drive Duct Clamp (150mm) 2 Pack

Model No.	Product
-----------	---------

CEFQB250WE	Deflecto Quiet Boost Ceiling Exhaust Fan - Wall/Eave Kit
------------	--



Ceiling Exhaust Fan Quiet Boost “QB” Metal Roof Kit

Components:

- EFLQ250 - Quiet Boost Ceiling Exhaust-Fan (250mm)
- RMC6M - Roof Mushroom Cowl with Mesh (150mm)
- GSPS062430 - Deflecto Clip-Seam Pipe (150mm x 610mm)
- KFM36 - Kensington Flashing Metal Roof (76mm - 150mm)
- FO603M - Deflecto Supurr-Flex Duct (150mm x 3.6M)
- MC6/2 - Deflecto Worm Drive Duct Clamp (150mm) 2 Pack
- BRACE - Galvanised Steel Bracing Strap (1M)
- Rivets & Drill Bits

Model No.	Product
-----------	---------

CEFQB250MR	Deflecto Quiet Boost Ceiling Exhaust Fan - Metal Roof Kit
------------	---



Ceiling Exhaust Fan Quiet Boost “QB” Tile Roof Kit

Components:

- EFLQ250 - Quiet Boost Ceiling Exhaust-Fan (250mm)
- RMC6M - Roof Mushroom Cowl with Mesh (150mm)
- GSPS062430 - Deflecto Clip-Seam Pipe (150mm x 610mm)
- KFT38 - Kensington Flashing Tile Roof (76mm - 203mm)
- FO603M - Deflecto Supurr-Flex Duct (150mm x 3.6M)
- MC6/2 - Deflecto Worm Drive Duct Clamp (150mm) 2 Pack
- BRACE - Galvanised Steel Bracing Strap (1M)
- Rivets & Drill Bits

Model No.	Product
-----------	---------

CEFQB250TR	Deflecto Quiet Boost Ceiling Exhaust Fan - Tile Roof Kit
------------	--

KEEP **COSY THIS WINTER**

WITH OUR HEAT TRANSFER KITS



12 MONTH
WARRANTY

FOR ALL HEAT
TRANSFER KITS

Scan For More
Information



Our Heat Transfer Kits

Heat Transfer Kits utilise and distribute existing warm air from a room with a single heat source (such as a fire or pot belly stove) to colder rooms within the home using an inline-fan.

Designed for safety, the kits come supplied with Australian Standards (AS/NZS 4859.1) approved fire-rated insulated ducting and the inline-fan shuts off in case of an electrical fault.

- ✓ Efficiently distributes existing warm air to up to 3 rooms.
- ✓ Supplied with Australian Standard Approved insulated ducting.
- ✓ Inline fan costs under 5¢ to run per kWh (based on HTK2 inline fan).

Available Kits: 1 to 1 Room Kit, 1 to 2 Room Kit & 1 to 3 Room Kit.
Complies with all NCC and AS/NZS Standards.

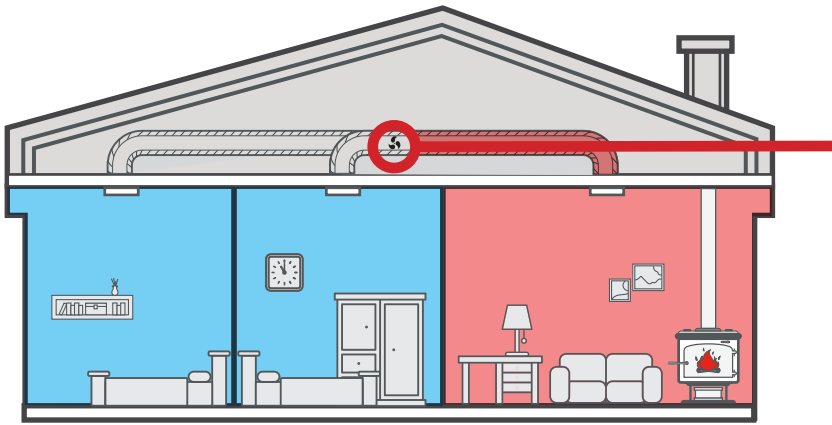

Gradually the inline-fan will warm the colder rooms creating a more temperature balanced house.

We strongly suggest that a qualified electrician install one of our Heat Transfer Kits.

1 to 1 Room Kit

Components:

- FT150F - Lightweight Inline-Fan (150mm)
- TFG6 - Deflecto Ceiling Diffuser/Intake (150mm)
- DJ150 - Deflecto Downjet Outlet (150mm)
- D603M - Rt.06 Insulated Ducting (150mm x 3M)
- D606M - Rt.06 Insulated Ducting (150mm x 6M)
- MC6/2 - Deflecto Worm Drive Duct Clamp (150mm) 2 Pack (x2)



Model No.	Product
HTK1	1 to 1 Room Heat Transfer Kit

1 to 2 Room Kit

Components:

- FTPRO150F - Injection Moulded Plastic Inline-Fan (150mm)
- TFG6 - Deflecto Ceiling Diffuser/Intake (150mm)
- DJ150 - Deflecto Downjet Outlet (150mm) (x2)
- D603M - Rt.06 Insulated Ducting (150mm x 3M)
- D606M - Rt.06 Insulated Ducting (150mm x 6M) (x2)
- DY666-I - Branch Take Off Insulated (150mm x 150mm x 150mm)
- MC6/2 - Deflecto Worm Drive Duct Clamp (150mm) 2 Pack (x4)



Model No.	Product
HTK2	1 to 2 Room Heat Transfer Kit

1 to 3 Room Kit

Components:

- FTPRO200F - Injection Moulded Plastic Inline-Fan (200mm)
- CD200 - Deflecto Ceiling Diffuser/Intake (200mm)
- DJ150 - Deflecto Downjet Outlet (150mm) (x3)
- D806M - Rt.06 Insulated Ducting (200mm x 6M)
- D606M - Rt.06 Insulated Ducting (150mm x 6M) (x2)
- DY866-I - Branch Take Off Insulated (200mm x 150mm x 150mm)
- DY666-I - Branch Take Off Insulated (150mm x 150mm x 150mm)
- MC8/2 - Deflecto Worm Drive Duct Clamp (200mm) 2 Pack (x2)
- MC6/2 - Deflecto Worm Drive Duct Clamp (150mm) 2 Pack (x4)



Model No.	Product
HTK3	1 to 3 Room Heat Transfer Kit



FT150F



FTPRO150F



FTPRO200F

FT Series Inline-Fan

The FT series of inline-fans are suitable for expelling or supplying cold or warm air in areas such as bathrooms, toilets, ensuites and homes. Designed for safety, the fans are fitted with a one-shot thermal fuse, that switches off in the event of an electrical fault. All fans have a 1-year warranty from installation.

Features:

- The FT150F is lightweight with a robust aluminium fan housing and high strength steel axial impellers.
- The FTPRO150F & FTPRO200F have two-speed settings for airflow control, a removable body for maintenance and an integrated mounting foot for easier installation. All fans can be mounted in any position.

Model No.	Product	Diameter (mm)	Carton Qty
FT150F	Mini-tube Inline-Fan	150	1
FTPRO150F	Pro-vent Inline-Fan	150	1
FTPRO200F	Pro-vent Inline-Fan	200	1

Professional installation recommended



DJ150



DJ200



DJ250

Downjet Diffuser

The downjet ceiling diffuser evenly streams air to a chosen area. Simple to install, it comes with spring loaded attachment arms that lock and secure the vent in place.

Features:

- Outlet vents can be closed by pushing in and turning the central control knob to activate the internal butterfly damper.

Model No.	Product	Colour	Inner Diameter	Outer Diameter	Carton Qty
DJ150	Downjet Diffuseer Outlet	White	150mm	240mm	1
DJ200	Downjet Diffuseer Outlet	White	200mm	290mm	1
DJ250	Downjet Diffuseer Outlet	White	250mm	340mm	1



CD150



CD200



CD250

Ceiling Diffuser

Commonly used for air intake, our Ceiling Diffuser has adjustable airflow control for general air intake or exhaust. Accepts air from surrounding areas and not directly below. Ideally suited for heat, smoke and vapour extraction/transfer.

Features:

- 180° airflow spread
- Adjustable inverted centre cone centre for desired airflow control
- Designed for easy installation and removal for cleaning

Model No.	Product	Colour	Inner Diameter	Outer Diameter	Carton Qty
CD150	Ceiling Diffuser/Intake	White	150mm	270mm	1
CD200	Ceiling Diffuser/Intake	White	200mm	320mm	1
CD250	Ceiling Diffuser/Intake	White	250mm	395mm	1
CD300	Ceiling Diffuser/Intake	White	300mm	440mm	1

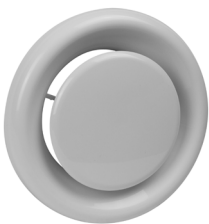

TFG6



MV125PFS

Euro Style Diffuser

Commonly used for air intake, the ceiling diffuser accepts air from surrounding surfaces making it ideal for warm air extraction/transfer.

Features:

- Plastic construction
- 180° airflow spread
- Adjustable inverted centre cone centre for desired airflow control
- Designed for easy installation and removal for cleaning

Model No.	Product	Inner Diameter	Outer Diameter	Carton Qty
TFG4	Euro Ceiling Diffuser/Intake	100mm	150mm	6
*MV125PFS	Euro Ceiling Diffuser	125mm	170mm	20
TFG6	Euro Ceiling Diffuser/Intake	150mm	200mm	6

**Limited Stock Available of MV125PFS Will Be Discontinued Once Stock Runs Out*

Budget Metallic Flexible Ducting

This Flexible Ducting is surrounded by metallic installation and is used in air transfer situations only. The metallic flexible ducting must not be used in rangehood or clothes dryer venting.



Model No.	Product	Diameter	Length	Carton Qty
SL430	Budget Metallic Flexible Duct	100mm	3M	1
SL530	Budget Metallic Flexible Duct	125mm	3M	1

Floor Vents

Present your floors with our wide range of stylish floor vents and accessories.



Polycarbonate Floor Vents

Our range of polycarbonate vents comes in 8 designer colours to suit any colour scheme. Constructed from polycarbonate plastic and featuring triple air dampers to provide streamlined airflow and control. The vents can be adjusted by simply sliding the middle damper. All vents have a 5-year replacement warranty.

Features:

- Maintenance and rust-free
- Dishwasher safe



Light Beige



Grey



White



Green



Cream



Slate



Coffee

Model No.	Product	Colour	Hole Size (mm)	Carton Qty
D201	Polycarbonate Floor Vent	Light Beige	300 (W) x 100 (L)	10
D202	Polycarbonate Floor Vent	Grey	300 (W) x 100 (L)	10
D204	Polycarbonate Floor Vent	White	300 (W) x 100 (L)	10
D205	Polycarbonate Floor Vent	Green	300 (W) x 100 (L)	10
D206	Polycarbonate Floor Vent	Cream	300 (W) x 100 (L)	10
D207	Polycarbonate Floor Vent	Slate	300 (W) x 100 (L)	10
D208	Polycarbonate Floor Vent	Coffee	300 (W) x 100 (L)	10

ABS Plastic Floor Vents

Constructed from durable ABS plastic and featuring a sleek look with rounded corners, the floor vents are both contemporary and durable. These vents have a smooth fully closing damper operation with flush button control mechanics to regulate airflow. All vents have a 5-year replacement warranty.

Features:

- High strength fabrication
- Dishwasher safe
- Low maintenance and rust free

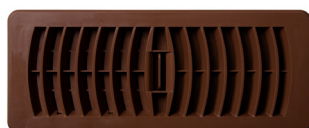

Iron Brown



Cream



Stone

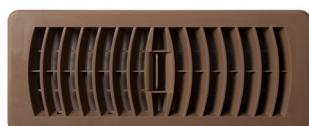

Earth

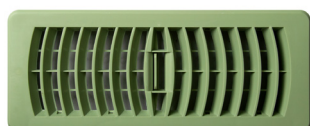

Gum Green



Cherrywood

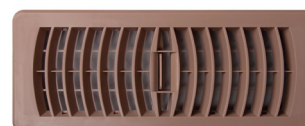

Dusk Musk

Model No.	Product	Colour	Hole Size (mm)	Carton Qty
RF41213	ABS Plastic Floor Vent	Iron Brown	300 (W) x 100 (L)	10
RF41217	ABS Plastic Floor Vent	Cream	300 (W) x 100 (L)	10
RF41218	ABS Plastic Floor Vent	Stone	300 (W) x 100 (L)	10
RF41226	ABS Plastic Floor Vent	Earth	300 (W) x 100 (L)	10
RF41244	ABS Plastic Floor Vent	Gum Green	300 (W) x 100 (L)	10
RF41249	ABS Plastic Floor Vent	Cherrywood	300 (W) x 100 (L)	10
RF41256	ABS Plastic Floor Vent	Dusk Musk	300 (W) x 100 (L)	10

Metal Floor Vents

Our range of metal floor vents is both modern and practical. The metal construction can withstand high traffic areas in the home, with a low profile for added safety benefits. With two styles to choose from and a large range of attractive colours, the metal vents complement any room. Adjustable Damper to regulate airflow.



Antique Brass

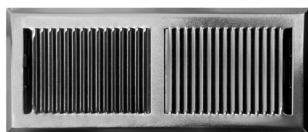

Nickel



White

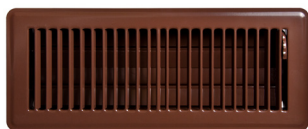

Chocolate



Grey



Beige

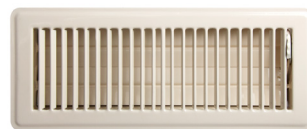

Smooth Cream



Antique Brass



Chrome



Polished Brass



White

Traditional

Model No.	Product	Colour	Hole Size (mm)	Carton Qty
MVANTBRASS	Metal Traditional Floor Vent	Antique Brass	300 (W) x 100 (L)	10
MVNICK	Metal Traditional Floor Vent	Nickel	300 (W) x 100 (L)	10
MVWHITE	Metal Traditional Floor Vent	White	300 (W) x 100 (L)	10
MVCHOC	Metal Traditional Floor Vent	Chocolate	300 (W) x 100 (L)	10
MVGREY	Metal Traditional Floor Vent	Grey	300 (W) x 100 (L)	10
DMR1228	Metal Traditional Floor Vent	Beige	300 (W) x 100 (L)	10
DMR1217	Metal Traditional Floor Vent	Smooth Cream	300 (W) x 100 (L)	10

Victorian

Model No.	Product	Colour	Hole Size (mm)	Carton Qty
MVICANTBRASS	Metal Victorian Floor Vent	Antique Brass	300 (W) x 100 (L)	10
MVICCHROME	Metal Victorian Floor Vent	Chrome	300 (W) x 100 (L)	10
MVICPBRASS	Metal Victorian Floor Vent	Polished Brass	300 (W) x 100 (L)	10
MVICWHITE	Metal Victorian Floor Vent	White	300 (W) x 100 (L)	10

Wooden Floor Vents

Low profile wooden floor vents blend into existing hardwood floors, the unfinished oak can be stained to match existing floor colour.



Polished Oak



Unpolished Oak

Model No.	Product	Colour	Hole Size (mm)	Carton Qty
WOODPOLOAK	Wooden Floor Vent	Polished Oak	300 (W) x 100 (L)	10
WOODUNFOAK	Wooden Floor Vent	Unpolished Oak	300 (W) x 100 (L)	10

Air Deflectors

Premium Unbreakable Air Deflector:

Improve heating efficiency and comfort by directing air across the floor and away from furniture and curtains. Constructed from premium clear polycarbonate, the air deflectors are unbreakable under normal use.

Large Air Deflector:

The Large Air Deflector is adjustable length (250 - 400mm) to deflect air for larger vents and is suitable for floor or wall use.

Air Deflector:

Improve heating efficiency and comfort by directing air across the floor and away from furniture and curtains.

Features:

- Adjustable 250 - 360mm (W) x 100mm (D)
- Clear polycarbonate plastic

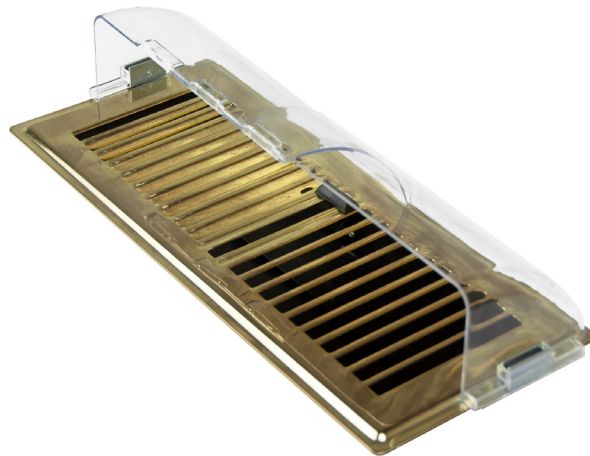

Model No.	Product	Size (mm)	Carton Qty
50	Deflecto Premium Air Deflector Unbreakable	360 (W) x 100 (L) x 100 (D)	24
51	Deflecto Large Air Deflector	450 (W) x 150 (L) x 100 (D)	12
99	Deflecto Ducted Heat Air Deflector	360 (W) x 100 (L) x 100 (D)	48

Plastic Floor Vent Boot

Made from black blown moulded plastic with an internal pivot damper for adjustable air volume control. Suits both metal and plastic floor vents.

Features:

- Allows for branch take-off to an additional room/outlet
- Suits 300 x 100mm & 350 x 150mm floor vents (sold separately)
- Secure using metal worm drive clamps (sold separately)



D302

Model No.	Product	Duct Diameter (mm)	Dimensions (mm)
D301	Floor Boot Duct	150	300 (W) x 100 (W)
D302	Floor Boot Duct	200	300 (W) x 100 (W)
D303	Floor Boot Duct	200	350 (W) x 150 (W)
D304	Floor Boot Duct	250	350 (W) x 150 (W)

Floor Duct Extension Kit

The floor duct extension kit is the ideal solution to extending an existing 200mm ducting heating system to branch off into an extra 150mm outlet. Kit comes with all needed components in one easy-to-use DIY kit.

Features:

- Allows for 150mm branch take-off to an additional room/outlet
- System suits 300 x 100mm floor vents (sold separately)

Components:

- D301 - Floor Boot Duct (300mm x 100mm)
- D606M - Rt.06 Insulated Ducting (150mm x 6M)
- D886 - Plastic Branch Take Off (200mm x 200mm x 150mm)
- MC8/2 - Deflecto Worm Drive Duct Clamp (200mm) (x2)
- MC6/2 - Deflecto Worm Drive Duct Clamp (150mm) (x2)

Model No.	Product	Duct Diameter (mm)
FDK150	Floor Duct Extension Kit	150



Vents

Complement your project with a wide range of inlet and outlet vents. From Stainless Steel to UV resistant polypropylene plastic.



HSM6WR

Roof Mushroom Cowl - Aluminium

The RMC range offers the highest protection from rain, back drafts and rodents with a unique and stylish design. The Cowl slips over the roof pipe to prevent rainwater from running down the inside of the pipe.

The Cowl is made of Aluminium with the cover's thickness being 1 mm and the neck being 0.6mm. The mesh is made of 304 stainless steel and **complies with BAL40 (Bushfire Attack Level)**.

Features:

- Efficient air/exhaust expulsion
- Suitable for roof ventilation only



Model No.	Product	Duct Diameter (mm)	Packaging	Carton Qty
RMC4M	Roof Mushroom Cowl Aluminium with Mesh	100	Loose	8
RMC5M	Roof Mushroom Cowl Aluminium with Mesh	125	Loose	8
RMC6M	Roof Mushroom Cowl Aluminium with Mesh	150	Loose	8
RMC8M	Roof Mushroom Cowl Aluminium with Mesh	200	Looset	8

PLEASE NOTE: The Roof Mushroom Cowl's Matches With Our GSPS & PPS Coded Clip-Seam Piping (See Page 39)



Cinder Mesh Insert

Manufactured from quality 304 grade stainless steel with less than 0.2mm openings, the inserts suit stainless steel venting applications and **complies with BAL40 (Bushfire Attack Level)**.

Features:

- Use the insert to block pests and vermin from entering ventilation systems where the existing vents do not have mesh.

Model No.	Product	Diameter Size (mm)	Packaging	Carton Qty
IMA100	Cinder Mesh Insert	100	Retail	20
IMA125	Cinder Mesh Insert	125	Retail	20
IMA150	Cinder Mesh Insert	150	Retail	20
IMA200	Cinder Mesh Insert	200	Retail	20



Eave Vent - Marine Grade Stainless Steel

The EVSS range are ideal for under eave ventilation, featuring a flush face. The open mesh makes them suitable for wall or ceilings as an inlet/outlet vent.

The Eave is made from quality 316 Marine Grade Stainless Steel. The Eave also **complies with BAL40 (Bushfire Attack Level)**, as the vent is supplied with a cinder mesh insert.

Features:

- Screws and Rubber seal included
- Egg-crate style grille to prevent pests and vermin from entering the system

Model No.	Product	Duct Diameter (mm)	External Dimensions (mm)	Packaging	Carton Qty
EVSS100	Kensington Eave Vent Stainless Steel	100	145	Retail	3
EVSS125	Kensington Eave Vent Stainless Steel	125	185	Retail	3
EVSS150	Kensington Eave Vent Stainless Steel	150	210	Retail	3
EVSS200B	Kensington Eave Vent Stainless Steel (Bulk)	200	265	Loose	24

The EVSS200B is Constructed From 304-Grade Stainless Steel



Gravity Louvre Vent - Marine Grade Stainless Steel

The GVSS range is designed to allow airflow to be released by opening the Louvres and then closing them when not in use. This keeps the vent closed during wind, and drafts and prevents pests and vermin from entering the system.

The Louvre is made from quality 316 Marine Grade Stainless Steel. The Louvre also **complies with BAL40 (Bushfire Attack Level)**, as the vent is supplied with a cinder mesh insert.

Features:

- Screws and Rubber seal included

Model No.	Product	Duct Diameter (mm)	External Dimensions (mm)	Packaging	Carton Qty
GVSS100	Kensington Gravity Vent Stainless Steel	100	155 (W) x 155 (L)	Retail	3
GVSS125	Kensington Gravity Vent Stainless Steel	125	185 (W) x 185 (L)	Retail	3
GVSS150	Kensington Gravity Vent Stainless Steel	150	185 (W) x 185 (L)	Retail	3
GVSS200B	Kensington Gravity Vent Stainless Steel	200	265 (W) x 265 (L)	Loose	12

The GVSS200B is Constructed From 304-Grade Stainless Steel

Hood Vent - Marine Grade Stainless Steel

The HVSS features an internal gravity flap allowing air to be expelled, whilst stopping cold air and pests from entering the system.

The Hood is made from quality 316 Marine Grade Stainless Steel. The Hood also **complies with BAL40 (Bushfire Attack Level)**, as the vent is supplied with a cinder mesh insert.

Features:

- Angle design for snow and heavy rain regions
- Screws and Rubber seal included



Model No.	Product	Duct Diameter (mm)	External Dimensions (mm)	Packaging	Carton Qty
HVSS100	Kensington Hood Vent Stainless Steel	100	155 (W) x 155 (L) x 80 (D)	Retail	3
HVSS125	Kensington Hood Vent Stainless Steel	125	185 (W) x 185 (L) x 90 (D)	Retail	3
HVSS150	Kensington Hood Vent Stainless Steel	150	185 (W) x 185 (L) x 90 (D)	Retail	3

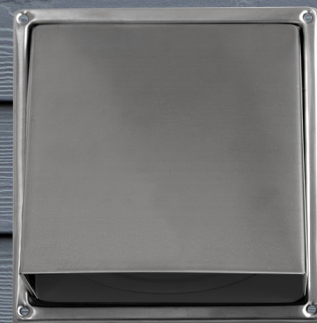

Dome Vent - Marine Grade Stainless Steel

The DVSS range is designed for a high level of protection against weather elements and can be used as an inlet or an outlet vent.

The Dome is made from quality 316 Marine Grade Stainless Steel. The Dome also **complies with BAL40 (Bushfire Attack Level)**, as the vent is supplied with a cinder mesh insert.

Features:

- Screws and Rubber seal included
- Curved design for snow and heavy rain regions



Model No.	Product	Duct Diameter (mm)	External Dimensions (mm)	Packaging	Carton Qty
DVSS100	Kensington Dome Vent Stainless Steel	100	155 (W) x 80 (D)	Retail	3
DVSS125	Kensington Dome Vent Stainless Steel	125	185 (W) x 90 (D)	Retail	3
DVSS150	Kensington Dome Vent Stainless Steel	150	210 (W) x 100 (D)	Retail	3
DVSS200B	Kensington Dome Vent Stainless Steel (Bulk)	200	260 (W) x 105 (D)	Loose	12

The DVSS200B is Constructed From 304-Grade Stainless Steel



Fixed Louvre Vent - Stainless Steel

The FLSS range is designed to allow airflow in both directions whilst preventing rain from entering the system.

The Louvre is made from quality 304 Grade Stainless Steel. The Louvre also **complies with BAL40 (Bushfire Attack Level)**, as the vent is supplied with a cinder mesh insert.

Features:

- Screws and Rubber seal included

Model No.	Product	Duct Diameter (mm)	External Dimensions (mm)	Packaging	Carton Qty
FLSS125B	Kensington Fixed Louvre Vent Stainless Steel	125	175 (W) x 175 (L)	Loose	24

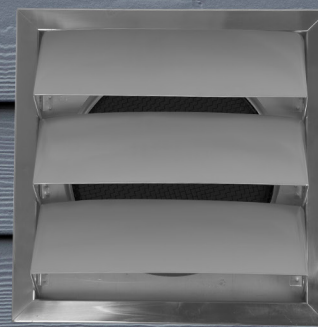



Under Eave Vent - Plastic

The under eave vent offers venting for ducting diameters up to 125mm. When there is no mechanical air movement, the damper closes off preventing vermin and back draft entry.

The Plastic Under Eave is made of UV resistant polypropylene plastic to withstand Australian climates.

Model No.	Product	Duct Diameter (mm)	Dimensions (mm)	Carton Qty
EVE	Under-Eave Vent	75 - 125	180 (W) x 260 (L) x 60 (D)	6

Gravity Louvre Vent - Plastic

The HSR range, allows air to be released by opening the Louvres and closing them when not in use. The Louvres are specially manufactured in a curved shape to assist in keeping the vent closed during wind, and drafts and prevent pests from entering the system.

The Gravity Louvre is made of UV resistant polypropylene plastic to withstand the Australian climate.

Features:

- Rounded edges with mounting holes in each corner
- 25mm deep rear spigot for ducting attachment.



Model No.	Product	Duct Diameter (mm)	External Dimensions (mm)	Packaging	Carton Qty
HSR4W	Deflecto Gravity Wall Vent - Plastic	100	150 (W) x 150 (L)	Retail	12
HSR5W	Deflecto Gravity Wall Vent - Plastic	125	205 (W) x 205 (L)	Retail	12
HSR6W	Deflecto Gravity Wall Vent - Plastic	150	205 (W) x 205 (L)	Retail	12
HS8W	Deflecto Gravity Wall Vent - Plastic	200	250 (W) x 250 (L)	Loose	10

DP411S



HS4W

Gravity Louvre with Split Rear Spigot - Plastic

Same features of the gravity louvred vents (above) and comes with a split rear spigot for attachment of aluminium clip-seam for use in dryer venting.

Constructed from UV resistant calcium-filled polypropylene plastic to withstand Australian climates.

Features:

- Rounded edges with mounting holes in each corner

Model No.	Product	Duct Diameter (mm)	External Dimensions (mm)	Packaging	Carton Qty
HS4W	Deflecto Gravity Wall Vent - Split Flange (Bulk)	100	150 (W) x 150 (L)	Loose	48
DP411S	Aluminium Pipe for HS4W	100	280	Loose	1



Fixed Louvre Vent - Plastic

The HSM vent range has vertical grilles between the Louvres, whilst the 125mm and 150mm vents have a 12mm mesh on their rear spigots to prevent pests and vermin from entering the system. The fixed Louvres can be used as an outlet or intake vent.

The Fixed Louvre is made of UV resistant polypropylene plastic to withstand the Australian climate.

Features:

- Rounded edges with mounting holes in each corner to suit modern decor



Model No.	Product	Duct Diameter (mm)	External Dimensions (mm)	Packaging	Carton Qty
HSM4WR	Deflecto Fixed Louvre Vent - Plastic	100	150 (W) x 150 (L)	Retail	24
HSM5WR	Deflecto Fixed Louvre Vent - Plastic	125	205 (W) x 205 (L)	Retail	6
HSM6WR	Deflecto Fixed Louvre Vent - Plastic	150	205 (W) x 205 (L)	Retail	6



Fixed Grille Vent with Screen - Plastic

The HGV range is for wall or eave mounting and can be used as an outlet or fresh air intake vent.

The Fixed Grille is made of UV resistant polypropylene plastic to withstand the Australian climate.

Features:

- Rounded edges with mounting holes in each corner
- Includes a fly-screen

Model No.	Product	Duct Diameter (mm)	External Dimensions (mm)	Packaging	Carton Qty
HGV4	Deflecto Grille Vent with Screen - Plastic	100	150 (W) x 150 (L)	Retail	12
HGV5	Deflecto Grille Vent with Screen - Plastic	125	205 (W) x 205 (L)	Retail	12
HGV6	Deflecto Grille Vent with Screen - Plastic	150	205 (W) x 205 (L)	Retail	12
HGV8	Deflecto Grille Vent with Screen - Plastic	200	250 (W) x 250 (L)	Loose	10



Aluminium Double Sided Door Grille

Facilitates airflow between rooms and assists in relieving pressure when the door is closed. Constructed from anodised aluminium, the vents are anti-corrosive and preserve appearance for minimal maintenance. The two-piece design simply clips together, eliminating the use of screws for easy installation.



Features:

- Suitable for doors 30-45mm thick
- Durable lightweight construction
- Anodised coating does not flake or peel
- Angled louvres provide privacy

Model No.	Product	Hole Dimensions (mm)	Packaging	Carton Qty
DG2406	Double Sided Door Grille	600 (W) x 150 (H)	Loose	1
DG2410	Double Sided Door Grille	600 (W) x 250 (H)	Loose	1
DG2412	Double Sided Door Grille	600 (W) x 300 (H)	Loose	1
DG2418	Double Sided Door Grille	600 (W) x 450 (H)	Loose	1
DG2424	Double Sided Door Grille	600 (W) x 600 (H)	Loose	1

Plastic Door Grille Set

Facilitates airflow between rooms and assists in relieving pressure when the door is closed. The two grilles screw together for door mounting.

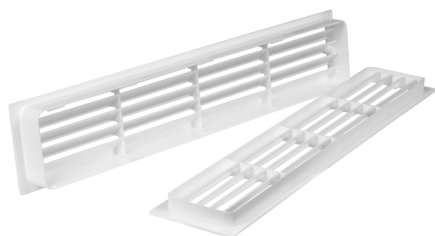

Features:

- Plastic construction
- Suitable for doors 27-45mm thick
- Angled louvres provide privacy

Model No.	Product	Hole Dimensions (mm)	Packaging	Carton Qty
6145	Door Vent Plastic	435 (W) x 75 (H)	Retail - Two Pieces	12

Plastic Single Sided Door/Wall Grille Vent

Facilitates airflow and air conditioning between rooms and assists in relieving pressure when the door and windows are closed. Use two MV450 on opposite sides of the door or wall for general ventilation. Use one or two adjustable MV450R for airflow control.

Features:

- Plastic construction
- Suitable for doors 27-45mm thick



Model No.	Product	Hole Dimensions (mm)	Packaging	Carton Qty
MV450R	Door Vent Plastic - Open or Close	435 (W) x 90 (H)	Bulk	12



Round Cupboard Vent

Push in round vent with horizontal open grilles, making them suitable for enclosed appliances such as fridges and clothes dryers that require ventilation.

Model No.	Product	Size (mm)	Rear Flange Diameter (mm)	Packaging	Carton Qty
MV50/2BVS	Round Vent Horizontal	60	48	2 Pack	40
C40/2W	Cupboard Vent	60	40	2 Pack	1

Multi-Directional Outlet - Ceiling

Allows air to be directed when and where required. The aerodynamically curved blades fully adjust to smoothly open or close in unison. Simple to maintain, the grille sections are designed to be easily removed for cleaning and eliminate noise by clipping into the main diffuser housing. Featuring a flush face, the vents blend in with the existing decor.

Features:

- Plastic construction
- Suitable for heating and cooling exhaust
- Adjustable grilles allows you to customise air direction
- Simple to clean and maintain

Two Way Multi-Directional Outlet

Features:

- Suits 150 or 200mm ducting
- Add 50mm to hole size for face size

Model No.	Product	Uses Adaptor	Hole Size (mm)
MDO602	Two Way Multi-Directional Outlet	M603 or M604	230 x 230

PLEASE NOTE: Requires "M Series Adaptor" To Match The Supply Duct (See Page 36)



Four Way Multi-Directional Outlet

Features:

- Suits 150, 200, 250 or 300mm ducting
- Add 50mm to hole size for face size

Model No.	Product	Uses Adaptor	Hole Size (mm)
MDO601	Four Way Multi-Directional Outlet	M603 or M604	230 x 230
MDO611	Four Way Multi-Directional Outlet	M612, M613 or M614	310 x 310
MDO621	Four Way Multi-Directional Outlet	M614, M622 or M623	360 x 360
MDO631	Four Way Multi-Directional Outlet	M632 or M633	395 x 395

PLEASE NOTE: Requires "M Series Adaptor" To Match The Supply Duct (See Page 36)



Six Way Multi-Directional Outlet

Features:

- Suits 400, 450 or 500mm ducting
- Add 50mm to hole size for face size

Model No.	Product	Uses Adaptor	Hole Size (mm)
MDO641	Six Way Multi-Directional Outlet	M642, M643 or M644	390 x 585
MDO651	Six Way Multi-Directional Outlet	M652 or M653	360 x 535

PLEASE NOTE: Requires "M Series Adaptor" To Match The Supply Duct (See Page 36)



Square Egg Crate Grille

Features:

- Fixed grille vent for intake or exhaust air
- Suits 150, 200, 300, 350 and 400 ducting
- Add 50mm to hole size for face size

Model No.	Product	Uses Adaptor	Hole Size (mm)
EG600	Egg Crate Grille	M603 or M604	230 x 230
EG625	Egg Crate Grille	M622, M623 or M624	360 x 360

PLEASE NOTE: Requires "M Series Adaptor" To Match The Supply Duct (See Page 36)

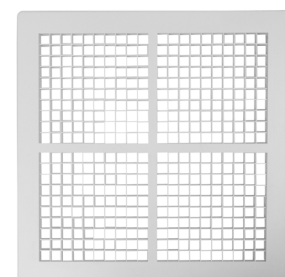

EG625

'M Series' Duct Adapters

The 'M Series' duct adaptors are designed to connect the multi-directional vents to ducting. The adaptor goes from square to round, the square side securely clips into the multi-directional vent frame whilst the round shape connects to the ducting.

Features:

- Plastic construction
- Simple maintenance



Suits 150mm Duct

Model No.	Product	Use With Multi Directional Outlet Model	Dimensions (mm)	Suits Duct (mm)
M603	M Series Duct Adaptor	MDO601, MDO602 or EG600	226 (W) x 226 (L) x 78 (D)	150

Suits 200mm Duct

Model No.	Product	Use With Multi Directional Outlet Model	Dimensions (mm)	Suits Duct (mm)
M604	M Series Duct Adaptor	MDO601, MDO602 or EG600	226 (W) x 226 (L) x 83 (D)	200
M612	M Series Duct Adaptor	MDO611	315 (W) x 315 (L) x 83 (D)	200

Suits 250mm Duct

Model No.	Product	Use With Multi Directional Outlet Model	Dimensions (mm)	Suits Duct (mm)
M613	M Series Duct Adaptor	MDO611	315 (W) x 315 (L) x 104 (D)	250

Suits 300mm Duct

Model No.	Product	Use With Multi Directional Outlet Model	Dimensions mm	Suits Duct (mm)
M614	M Series Duct Adaptor	MDO611	315 (W) x 315 (L) x 123 (D)	300
M622	M Series Duct Adaptor	MDO621 or EG625	365 (W) x 365 (L) x 80 (D)	300

Suits 350mm Duct

Model No.	Product	Use With Multi Directional Outlet Model	Dimensions (mm)	Suits Duct (mm)
M623	M Series Duct Adaptor	MDO621 or EG625	365 (W) x 365 (L) x 80 (D)	350
M632	M Series Duct Adaptor	MDO631	399 (W) x 399 (L) x 80 (D)	350

Suits 400mm Duct

Model No.	Product	Use With Multi Directional Outlet Model	Dimensions (mm)	Suits Duct (mm)
M624	M Series Duct Adaptor	MDO621 or EG625	365 (W) x 365 (L) x 80 (D)	400
M633	M Series Duct Adaptor	MDO631	399 (W) x 399 (L) x 80 (D)	400
M642	M Series Duct Adaptor	MDO641	397 (W) x 590 (L) x 80 (D)	400
M652	M Series Duct Adaptor	MDO651 or EG655	365 (W) x 542 (L) x 80 (D)	400

Suits 450mm Duct

Model No.	Product	Use With Multi Directional Outlet Model	Dimensions (mm)	Suits Duct (mm)
M643	M Series Duct Adaptor	MDO641	397 (W) x 590 (L) x 80 (D)	450
M653	M Series Duct Adaptor	MDO651 or EG655	365 (W) x 542 (L) x 80 (D)	450

Suits 500mm Duct

Model No.	Product	Use With Multi Directional Outlet Model	Dimensions (mm)	Suits Duct (mm)
M644	M Series Duct Adaptor	MDO641	397 (W) x 590 (L) x 80 (D)	500

Return Air Grille

Used to draw air into a heating or cooling system, the return air grilles can be positioned in the ceiling or wall. The single-piece constructed return air grilles are capable of carrying high airflow and operate quietly. A scratch and chip-resistant plastic frame suits high-traffic areas. Available with a filter option for better air quality control.

Features:

- Injection-molded plastic

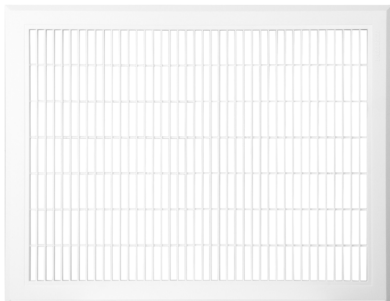

Unfiltered			
Model No.	Product	Colour	Hole Size (mm)
XRAG404	Unfiltered Return Air Grille	White	380 x 510
XRAG434	Unfiltered Return Air Grille	White	405 x 760

Extra Information

- Use adaptor box (below) for ceiling installation
- Use mounting box (below) for wall installation

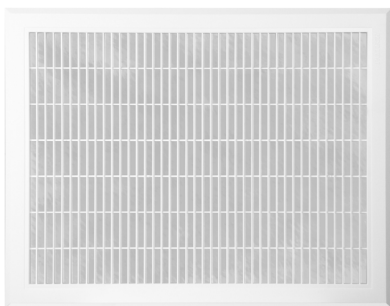

Filtered			
Model No.	Product	Colour	Hole Size (mm)
XRAG414	Filtered Return Air Grille	White	380 x 510
XRAG444	Filtered Return Air Grille	White	405 x 760

Extra Information

- Use adaptor box (below) for ceiling installation
- Use mounting box (below) for wall installation

Adaptor Box

Use with return air grille for ceiling installation.

Features:

- Round end of adaptor connects to ducting
- Plastic construction

Model No.	Product	Colour	Duct Size (mm)	Hole Size (mm)
XRAG425	Adaptor Box	Black	300	380 x 510
XRAG426	Adaptor Box	Black	350	380 x 510
XRAG427	Adaptor Box	Black	350	405 x 760
XRAG428	Adaptor Box	Black	400	405 x 760

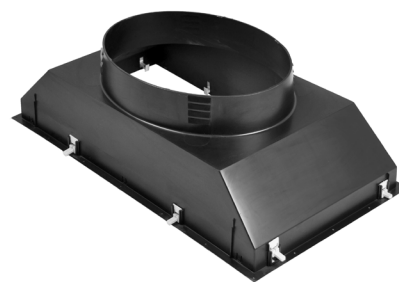

PLEASE NOTE: When using the Adaptor Box, the Mounting Frame is not required with using the Adaptor Box.

Mounting Frame

Features:

- Use with return air grille for wall installation
- Does not connect to ducting
- Plastic construction



Model No.	Product	Colour	Hole Size (mm)
XRAG410	Mounting Frame - 380 x 510mm	Silver	380 x 510
XRAG440	Mounting Frame - 405 x 760	Silver	405 x 760

PLEASE NOTE: When using the Mounting Frame, the Adaptor Box is not required with using the Mounting Frame.

Ducting & Accessories

From flexible ducts to duct connectors, we have the component that you'll need for any ventilation project.



Roof Flashing

Keep water from seeping and causing structural damage by using roof flashing to direct the flow of water away from the pipe opening. The flashing stretches over the penetration and forms a tight seal. Designed for Australian conditions, the low profile bases provide resistance to weathering and easily conform to roof profiles and pitches for simple installation.

Flashing for Metal Roof

Features:

- EPDM rubber with aluminium trim
- Temperature rating of -50°C and up to 115°C
- Lower square base covers larger openings, more forgiving for penetration openings and steeper roof pitch
- Clear markings in metric and imperial measurements

Flashing for Tile Roof

Features:

- Lead free aluminium base and EPDM rubber top
- Temperature rating of -50°C and up to 115°C
- Clear markings in metric and imperial measurements
- Paintable to match roof colour (after applying a standard etched primer)

Metal Roof Flashing				
Model No.	Product	Suits Pipe Size (mm)	Base Size (mm)	Packaging
DFE100B	Dektite Premium Micro	0-35	100 (W) x 100 (L)	Loose
DFE101B	Dektite Premium #1	0-55	139 (W) x 139 (L)	Loose
DFE102BA	Dektite Premium #2	50-70	178 (W) x 178 (L)	Loose
DFE103B	Dektite Premium #3	5-127	221 (W) x 221 (L)	Loose
DFE104B	Dektite Premium #4	75-175	280 (W) x 280 (L)	Loose
DFE105B	Dektite Premium #5	100-200	310 (W) x 310 (L)	Loose
DFE106B	Dektite Premium #6	125-230	363 (W) x 363 (L)	Loose
DFE107B	Dektite Premium #7	150-300	456 (W) x 456 (L)	Loose
DFE108B	Dektite Premium #8	170-355	496 (W) x 496 (L)	Loose
KFM23	Kensington Metal Roof #2	51-70	175 (W) x 175 (L)	Loose
KFM36	Kensington Metal Roof #3	76-150	250 (W) x 250 (L)	Loose



Tile Roof Flashing				
Model No.	Product	Suits Pipe Size (mm)	Base Size (mm)	Packaging
SDA100B	Dektite Aluminium	12-70	500 (W) x 600 (L)	Loose
SDA101B	Dektite Aluminium #1	50-170	500 (W) x 600 (L)	Loose
KFT38	Kensington Tile Roof #1	76-203	500 (W) x 600 (L)	Loose



Clip-Seam Pipe

Made from 30 gauge galvanised steel, the unique clip-seam has a smooth internal finish for maximum airflow efficiency. Both seams connect together at one end and work up the length to form a solid pipe. Crimped end offers a male connection to pipe or ducting.



610mm Length				
Model No.	Product	Diameter (mm)	Length (mm)	Packaging
GSPS042430	Clip-Seam Pipe	100	610	Loose
GSPS052430	Clip-Seam Pipe	125	610	Loose
GSPS062430	Clip-Seam Pipe	150	610	Loose
GSPS082430	Clip-Seam Pipe	200	610	Loose

1.2M Length				
Model No.	Product	Diameter (mm)	Length (M)	Packaging
PPS04430	Clip Seam Pipe	100	1.2	Loose
PPS05430	Clip Seam Pipe	125	1.2	Loose
PPS06430	Clip-Seam Pipe	150	1.2	Loose
PPS08430	Clip-Seam Pipe	200	1.2	Loose



Semi Rigid Ducting

Supplied in a compressed length, this form of Semi Rigid Ducting expands and holds its shape and full diameter even when bends are applied. Constructed from continuous spiral bound aluminium, the ducting is self supportive needing only minimal fittings or mechanics each end for additional support. Ideal for straight and indirect venting installations for clothes dryers, rangehoods, bathrooms and other general venting applications.

Features:

- Complies with Australian Standards - AS1668.1
- 4 - Zero fire rating to Australian Standards - 1530.3
- Temperature rating -70 °C to +220 °C
- Manufactured material thickness 0.89mm

1.4M Length

Model No.	Product	Diameter (mm)	Length (M)	Packaging
AO4014MR	Deflecto Semi Rigid Aluminium Duct (100mm)	100	1.4	Loose
AO5014MR	Deflecto Semi Rigid Aluminium Duct (125mm)	125	1.4	Loose
AO6014MR	Deflecto Semi Rigid Aluminium Duct (150mm)	150	1.4	Loose

3M Length

Model No.	Product	Diameter (mm)	Length (M)	Packaging
AO48MX/9	Deflecto Semi Rigid Duct with Clamps (MC4/2) (100mm)	100	3	Retail
AO403M	Deflecto Semi Rigid Aluminium Duct (Bulk) (100mm)	100	3	Loose
AO403MR	Deflecto Semi Rigid Aluminium Duct (100mm)	100	3	Retail
AO503M	Deflecto Semi Rigid Aluminium Duct (Bulk) (125mm)	125	3	Loose
AO503MR	Deflecto Semi Rigid Aluminium Duct (125mm)	125	3	Retail
AO603M	Deflecto Semi Rigid Aluminium Duct (Bulk) (150mm)	150	3	Loose
AO603MR	Deflecto Semi Rigid Aluminium Duct (150mm)	150	3	Retail
AO803M	Deflecto Semi Rigid Aluminium Duct (Bulk) (200mm)	200	3	Loose

Flexible Ducting

Flexible multi-layered metallic ducting is ideal for general purpose ventilation and can be easily navigated around tight bends. The multi-purpose ducting can be used for low to medium pressure exhaust venting of bathrooms, electric clothes dryers and other applications.

Features:

- Complies with Australian Standards - AS1668.1
- 4 - Zero fire rating to Australian Standards - 1530.3
- Temperature rating -18 °C to +130 °C
- Manufactured material thickness 0.89mm



2.4M Length

Model No.	Product	Diameter (mm)	Length (M)	Packaging
FO408B	Deflecto Supurr-Flex Ducting (100mm)	100	2.4	Retail

3.6M Length

Model No.	Product	Diameter (mm)	Length (M)	Packaging
FO503M	Deflecto Supurr-Flex Ducting (125mm)	125	3.6	Retail
FO603M	Deflecto Supurr-Flex Ducting (150mm)	150	3.6	Retail
FO803M	Deflecto Supurr-Flex Ducting (200mm)	200	3.6	Retail

7.6M Length

Model No.	Product	Diameter (mm)	Length (M)	Packaging
FUL0425	Deflecto Supurr-Flex Ducting (100mm)	100	7.6	Retail
FUL0525	Deflecto Supurr-Flex Ducting (125mm)	125	7.6	Retail
FUL0625	Deflecto Supurr-Flex Ducting (150mm)	150	7.6	Retail
FUL0825	Deflecto Supurr-Flex Ducting (200mm)	200	7.6	Retail

Insulated Ducting

Australian Made Flexible silver/black core ducting surrounded by white polyester insulation. Supplied in a strong, silver foil outer sleeve to help minimise the effects of external conditions on internal duct temperatures.

Features:

- Complies with AS/NZS 4859.1
- Insulated with allergen-free polyester fibre
- Keep taut for maximum airflow efficiency
- Rated operating temperature rating: -10°C to +80°C
- Rated operating pressure: 100 Pa positive, 200 Pa negative



Level Rt 0.6 Insulated

Use Rt 0.6 thermal rating for warm or cool air transfer where there is no direct connection to a heater or cooler.

3M Length				
Model No.	Product	Diameter (mm)	Length (M)	Packaging
D603M	Rt 0.6 Insulated Duct (150mm)	150	3	Loose
D803M	Rt 0.6 Insulated Duct (200mm)	200	3	Loose
D1003M	Rt 0.6 Insulated Duct (250mm)	250	3	Loose
D1203M	Rt 0.6 Insulated Duct (300mm)	300	3	Loose
6M Length				
Model No.	Product	Diameter (mm)	Length (M)	Packaging
D606M	Rt 0.6 Insulated Duct (150mm)	150	6	Loose
D806M	Rt 0.6 Insulated Duct (200mm)	200	6	Loose
D1006M	Rt 0.6 Insulated Duct (250mm)	250	6	Loose
D1206M	Rt 0.6 Insulated Duct (300mm)	300	6	Loose

Level Rt 1.0 Insulated

Use Rt 1.0 thermal rated ducting when there is no direct connection to a heater or cooler and the ceiling floor/wall space is enclosed.

6M Length				
Model No.	Product	Diameter (mm)	Length (M)	Packaging
D606M+	Rt 1.0 Insulated Duct (150mm)	150	6	Loose
D806M+	Rt 1.0 Insulated Duct (200mm)	200	6	Loose
D1006M+	Rt 1.0 Insulated Duct (250mm)	250	6	Loose
D1206M+	Rt 1.0 Insulated Duct (300mm)	300	6	Loose

Level Rt 1.5 Insulated

Use Rt 1.5 thermal rated ducting when there is direct connection to a heater or cooler and the ceiling floor or wall space is not enclosed in alpine areas.

6M Length				
Model No.	Product	Diameter (mm)	Length (M)	Packaging
D606M++	Rt 1.5 Insulated Duct (150mm)	150	6	Loose
D806M++	Rt 1.5 Insulated Duct 200mm)	200	6	Loose
D1006M++	Rt 1.5 Insulated Duct (250mm)	250	6	Loose
D1206M++	Rt 1.5 Insulated Duct (300mm)	300	6	Loose

Y Branch Take-Off

Made from black-blown moulded plastic, Y branches allow for a venting system to be directed to/received from two evenly distributed areas.

Features:

- Not recommended for rangehood ventilation
- Available in insulated or uninsulated



Uninsulated		
Model No.	Product	Suits Pipe Size (mm)
DY644	Y Connector	150 x 100 x 100
DY666	Y Connector	150 x 150 x 150
DY866	Y Connector	200 x 150 x 150
DY1088	Y Connector	250 x 200 x 200

Insulated		
Model No.	Product	Suits Pipe Size (mm)
DY644-I	Y Connector (Insulated)	150 x 100 x 100
DY666-I	Y Connector (Insulated)	150 x 150 x 150
DY866-I	Y Connector (Insulated)	200 x 150 x 150
DY1088-I	Y Connector (Insulated)	250 x 200 x 200

Single Branch Take-Off

Made from black blown molded plastic, single branches allow for a venting system to be directed to/received from two areas. The 45° angle take off offers a more subtle volume of air to a secondary room as the majority of airflow will be sent to the in-line outlet.

Features:

- Not recommended for rangehood ventilation
- Available in insulated or uninsulated



Uninsulated		
Model No.	Product	Suits Pipe Size (mm)
D666	Branch Take Off	150 x 150 x 150
D866	Branch Take Off	200 x 150 x 150
D886	Branch Take Off	200 x 200 x 150
D888	Branch Take Off	200 x 200 x 200
D1086	Branch Take Off	250 x 200 x 150
D1088	Branch Take Off	250 x 200 x 200
D10108	Branch Take Off	250 x 250 x 200
D12108	Branch Take Off	300 x 250 x 200
D121010	Branch Take Off	300 x 250 x 250

Insulated		
Model No.	Product	Suits Pipe Size (mm)
D666-I	Branch Take Off (Insulated)	150 x 150 x 150
D866-I	Branch Take Off (Insulated)	200 x 150 x 150
D886-I	Branch Take Off (Insulated)	200 x 200 x 150
D888-I	Branch Take Off (Insulated)	200 x 200 x 200
D1086-I	Branch Take Off (Insulated)	250 x 200 x 150
D1088-I	Branch Take Off (Insulated)	250 x 200 x 200
D10108-I	Branch Take Off (Insulated)	250 x 250 x 200

Duct Connectors

Duct connecting sleeves are used to extend the length of flexible and/or Semi Rigid Ducting. Simply place a matching size metal worm drive clamp over the end of the ducting, insert one end of the sleeve into the ducting, position the clamp and tighten.

Features:

- Constructed from galvanised steel
- Compatible with all duct types
- Simple installation



DAC4



DAC6



DAC10

Model No.	Product	Diameter (mm)	External Size (mm)	Material	Carton Qty
DAC4	Duct Connector	100	110 x 100	Galvanised Steel	4
DAC5	Duct Connector	125	110 x 125	Galvanised Steel	4
DAC6	Duct Connector	150	110 x 150	Galvanised Steel	4
DAC8	Duct Connector	200	150 x 200	Galvanised Steel	4
DAC10	Duct Connector	250	150 x 250	Galvanised Steel	4
DAC12	Duct Connector	300	150 x 300	Galvanised Steel	4

Increaser/Reducers

A secure way to increase/decrease duct size in gradual staged sections to minimise back flow pressures when increasing/decreasing diameters.

Features:

- Internally smooth to maximise airflow
- Ducting can be clamped or riveted



DIRB54



DIRB65



DIRB86

Model No.	Product	Joins (mm)	Length (mm)	Material	Carton Qty
DIRB54	Duct Increaser	100 - 125	120mm	Aluminium	4
DIRB65	Duct Increaser	125 - 150	150mm	Aluminium	4
DIRB86	Duct Increaser	150 - 200	180mm	Aluminium	4

Adjustable Elbows - 0° to 90°

Adjustable elbows are used to make turns in Semi Rigid Ducting up to 90°. Each section easily rotates and is constructed from galvanised steel providing protection against fire and corrosion.

Features:

- Ducting can be clamped or riveted



Model No.	Product	Diameter (mm)	Material	Carton Qty
ELB049030	Adjustable Elbow	100	Galvanised Steel	1
ELB059030	Adjustable Elbow	125	Galvanised Steel	1
ELB069030	Adjustable Elbow	150	Galvanised Steel	1
ELB089030	Adjustable Elbow	200	Galvanised Steel	1

Please Note: The Adjustable Elbows Can Be Used In Conjunction With Clip-Seam Piping (See Page 39)

Draft Blockers

In-line draft blockers assist in preventing back flow from entering ventilation systems. Ideally installed in rangehood ventilation exhausting out through the roof. Manufactured with an internal spring-loaded butterfly damper, the damper opens when air passes through and closes when the venting system is not in use.

Features:

- Install at regular intervals to ensure there is no blockage

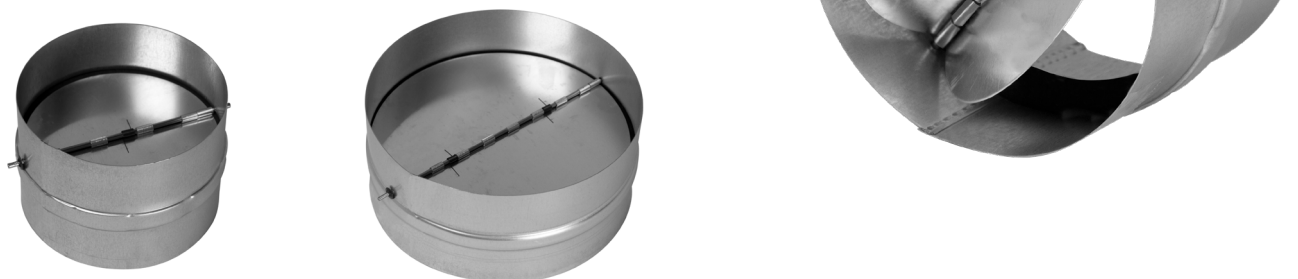

DBV125

DBV200

Model No.	Product	Diameter (mm)	Length (mm)	Material	Carton Qty
DBV100	Draft Blocker	100	88	Galvanised Steel	1
PDB125	Draft Blocker	125	88	Plastic	100
DBV125	Draft Blocker	125	88	Galvanised Steel	1
DBV150	Draft Blocker	150	88	Galvanised Steel	1
DBV200	Draft Blocker	200	88	Galvanised Steel	1

Metal Worm Drive Duct Clamps

Metal worm drive clamps are the most effective way to attach ducting to a fitting. Eliminates the use of tape or cable ties that over time can become loose from excessive air pressures, temperature or condensation.

Features:

- Stainless steel construction
- Easy to use
- Single piece construction



Model No.	Product	Diameter	Packaging	Carton Qty
MC4/2	Metal Worm Drive Duct Clamps - 100mm (2 pack)	Up to 114mm	Retail - 2 pack	12
MC5/2	Metal Worm Drive Duct Clamps - 125mm (2 pack)	Up to 139mm	Retail - 2 pack	12
MC6/2	Metal Worm Drive Duct Clamps - 150mm (2 pack)	Up to 165mm	Retail - 2 pack	12
MC8/2	Metal Worm Drive Duct Clamps - 200mm (2 pack)	Up to 216mm	Retail - 2 pack	6



CRA



SCA

Stainless Steel Clamp on Roll

Used in conjunction with a locking device, the stainless steel clamp allows any size worm drive clamp to be made up on site, eliminating the inconvenience of carrying various sizes on site.

Features:

- 30M x 9mm x 0.6 roll of stainless steel band in per-calibrated ABS plastic dispenser
- Quick and easy system
- Locking mechanism
- SCA - Low carbon steel nickel plated
- Screw - 7mm cross slotted hex head in galvanised steel

Model No.	Product	Length (M)	Pack of
CRA	Stainless Steel Clamp Band on Roll - 30M	30	-
SCA	Stainless Steel Clamp Band With Locking Screws	-	50 (25 pairs)

Model No.	Page	Model No.	Page	Model No.	Page	Model No.	Page
50	31	D202	29	DFE108B	43	DY644	46
51	31	D204	29	DG2406	38	DY644-I	46
99	31	D205	29	DG2410	38	DY666	46
6145	38	D206	29	DG2412	38	DY666-I	46
AO4014MR	44	D207	29	DG2418	38	DY866	46
AO403M	44	D208	29	DG2424	38	DY866-I	46
AO403MR	44	D301	31	DIRB54	47	EG600	39
AO48MX/9	44	D303	31	DIRB65	47	EG625	39
AO5014MR	44	D304	31	DIRB86	47	ELB049030	48
AO503M	44	D603M	45	DJ150	26	ELB059030	48
AO503MR	44	D606M	45	DJ200	26	ELB069030	48
AO6014MR	44	D606M+	45	DJ250	26	ELB089030	48
AO603M	44	D606M++	45	DK4W	18	EVE	36
AO603MR	44	D666	46	DMR1217	30	EVSS100	33
AO803M	44	D666-I	46	DMR1228	30	EVSS125	33
C40/2W	38	D803M	45	DP411S	36	EVSS150	33
CD150	27	D806M	45	DV4A	18	EVSS200B	33
CD200	27	D806M+	45	DVKFPL	19	FD2001	10
CD250	27	D806M++	45	DVKFPS	19	FD2002	10
CD300	27	D866	46	DVKFPW	19	FD2003	10
CEF200MR	22	D866-I	46	DVS1	14	FD2004	10
CEF200TR	22	D886	46	DVS1SS	14	FD2005	10
CEF200WE	22	D886-I	46	DVS2	13	FD2006	10
CEFQB250MR	23	D888	46	DVS3	13	FD2008	10
CEFQB250TR	23	D888-I	46	DVS4	15	FD2009	11
CEFQB250WE	23	DAC4	47	DVS5	14	FD2010	11
CRA	49	DAC5	47	DVS6	15	FD2011	11
D1003M	45	DAC6	47	DVSC	16	FD2012	11
D1006M	45	DAC8	47	DVSD	16	FD2013	11
D1006M+	45	DAC10	47	DVSE	16	FD2015	11
D1006M++	45	DAC12	47	DVSGR	16	FD2016	11
D10108	46	DB4K	17	DVSI	16	FD2017	11
D10108-I	46	DBV100	48	DVSO	16	FDK150	31
D1086	46	DBV125	48	DVSS100	35	FLSS125B	35
D1086-I	46	DBV150	48	DVSS125	35	FO408B	44
D1088	46	DBV200	48	DVSS150	35	FO503M	44
D1088-I	46	DFE100B	43	DVSS200B	35	FO603M	44
D1203M	45	DFE101B	43	DVSSC	17	FO803M	44
D1206M	45	DFE102BA	43	DVSU	17	FT150F	26
D1206M+	45	DFE103B	43	DVSWI	17	FTPRO150F	26
D1206M++	45	DFE104B	43	DVSWO	17	FTPRO200F	26
D121010	46	DFE105B	43	DVSWP	17	FUL0425	44
D12108	46	DFE106B	43	DY1088	46	FUL0525	44
D201	29	DFE107B	43	DY1088-I	46	FUL0625	44

Model No.	Page	Model No.	Page	Model No.	Page	Model No.	Page
FUL0825	44	M642	40	RHK125T	5		
GSPS042430	43	M643	40	RHK125W	7		
GSPS052430	43	M644	40	RHK125WSS	7		
GSPS062430	43	M652	40	RHK150E	6		
GSPS082430	43	M653	40	RHK150ESS	6		
GVSS100	34	MC4/2	49	RHK150T	5		
GVSS125	34	MC5/2	49	RHK150W	7		
GVSS150	34	MC6/2	49	RHK150WSS	7		
GVSS200B	34	MC8/2	49	RHK200E	6		
HGV4	37	MDO601	39	RHK200ESS	6		
HGV5	37	MDO602	39	RHK200T	5		
HGV6	37	MDO611	39	RHK200W	7		
HGV8	37	MDO621	39	RHK200WSS	7		
HSM4WR	37	MDO631	39	RHKE65	9		
HSM5WR	37	MDO651	39	RHKMR65	8		
HSM6WR	37	MV125PFS	27	RHKTR65	8		
HSR4W	36	MV450R	38	RMC4M	33		
HSR5W	36	MV50/2BVS	38	RMC5M	33		
HSR6W	36	MVANTBRASS	30	RMC6M	33		
HTK1	25	MVCHOC	30	RMC8M	33		
HTK2	25	MVGREY	30	SCA	49		
HTK3	25	MVICANTBRASS	30	SDA100B	43		
HVSS100	34	MVICCHROME	30	SDA101B	43		
HVSS125	34	MVICPBRASS	30	SL430	27		
HVSS150	34	MVICWHITE	30	SL530	27		
IMA100	33	MVNICK	30	TFG4	27		
IMA125	33	MVWHITE	30	TFG6	27		
IMA150	33	PDB125	48	WOODPOLOAK	30		
IMA200	33	PPS04430	43	WOODUNFOAK	30		
KFM23	43	PPS05430	43	XRAG404	41		
KFM36	43	PPS06430	43	XRAG410	41		
KFT38	43	PPS08430	43	XRAG414	41		
LTF	18	RF41213	29	XRAG425	41		
LTKA	18	RF41217	29	XRAG426	41		
M603	40	RF41218	29	XRAG427	41		
M604	40	RF41226	29	XRAG428	41		
M612	40	RF41244	29	XRAG434	41		
M613	40	RF41249	29	XRAG440	41		
M614	40	RF41256	29	XRAG444	41		
M622	40	RHA5	9				
M623	40	RHF5R	9				
M624	40	RHF6R	9				
M632	40	RHK125E	6				
M633	40	RHK125ESS	6				

Ventilation Solutions For Every Home

© 2023 JPM International Pty Ltd

JPM Brands | Deflecto
Melbourne VIC | 03 9729 9777 | info@jpmark.com.au

Edition 2.2.2